

XTreme EMS

Dimensions

Document - English 2.00

FRONT VIEW

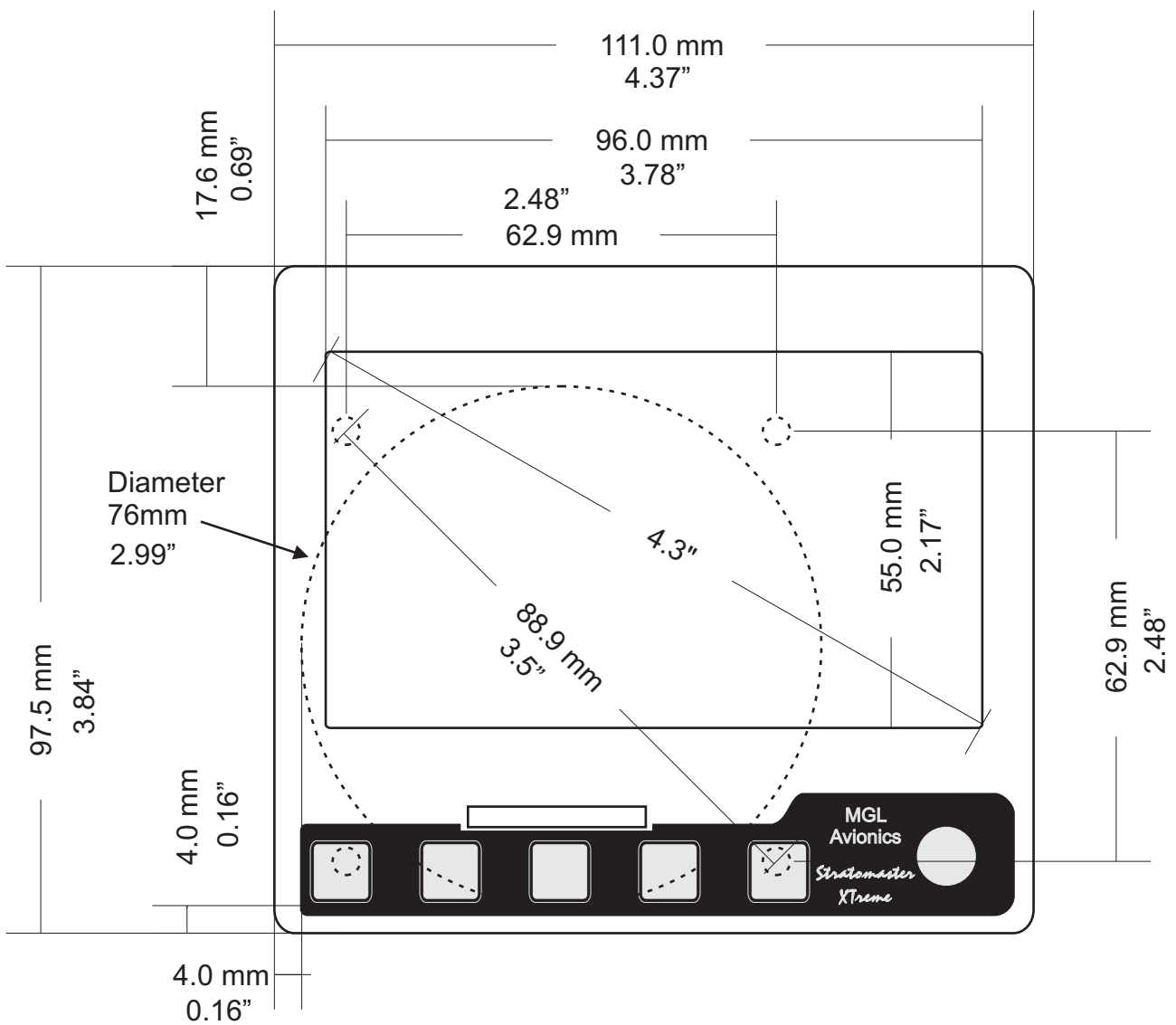

SIDE VIEW

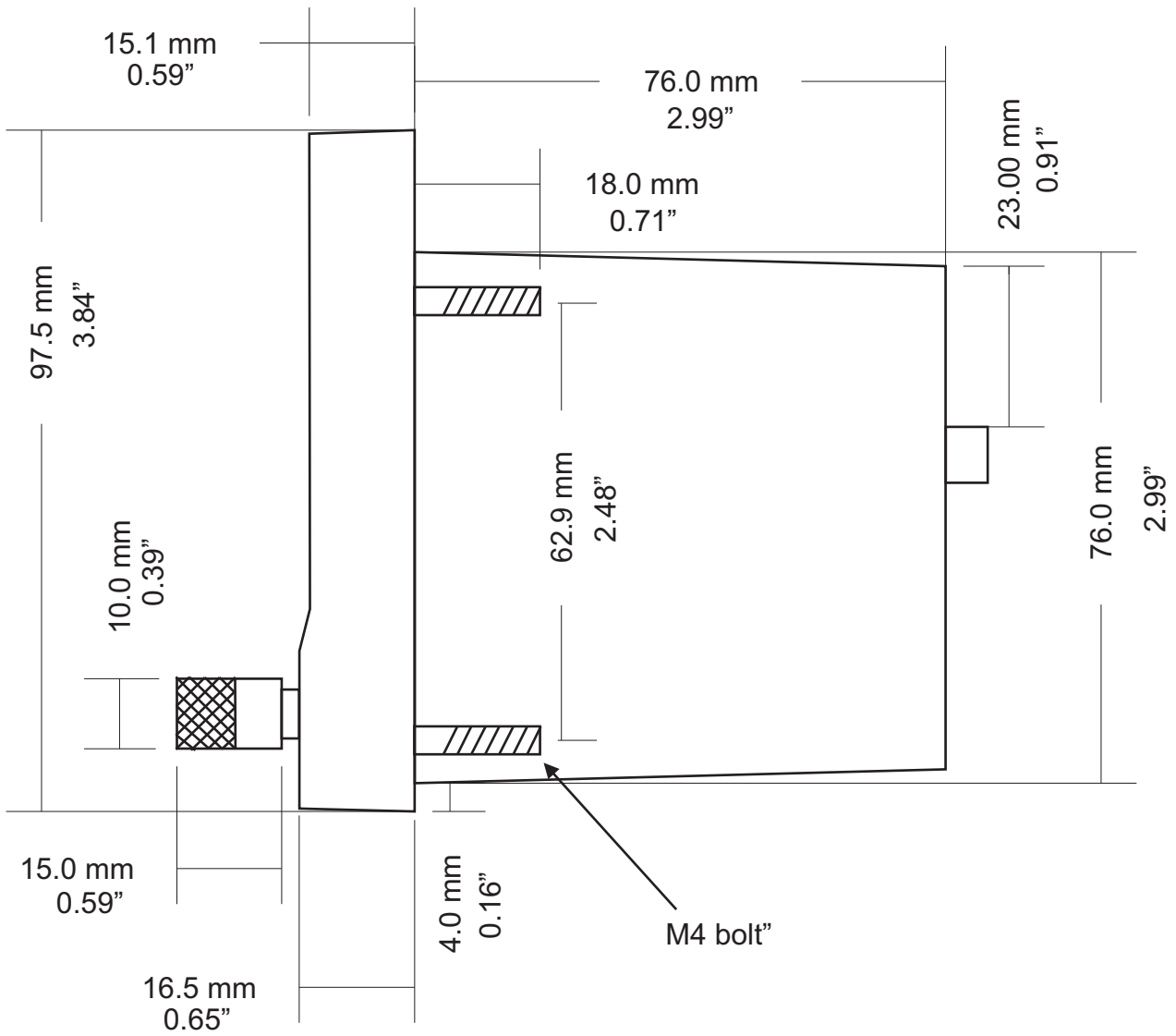

TOP VIEW

