

Vega FF-4

Fuel Computer

Operating Manual – English 1.07

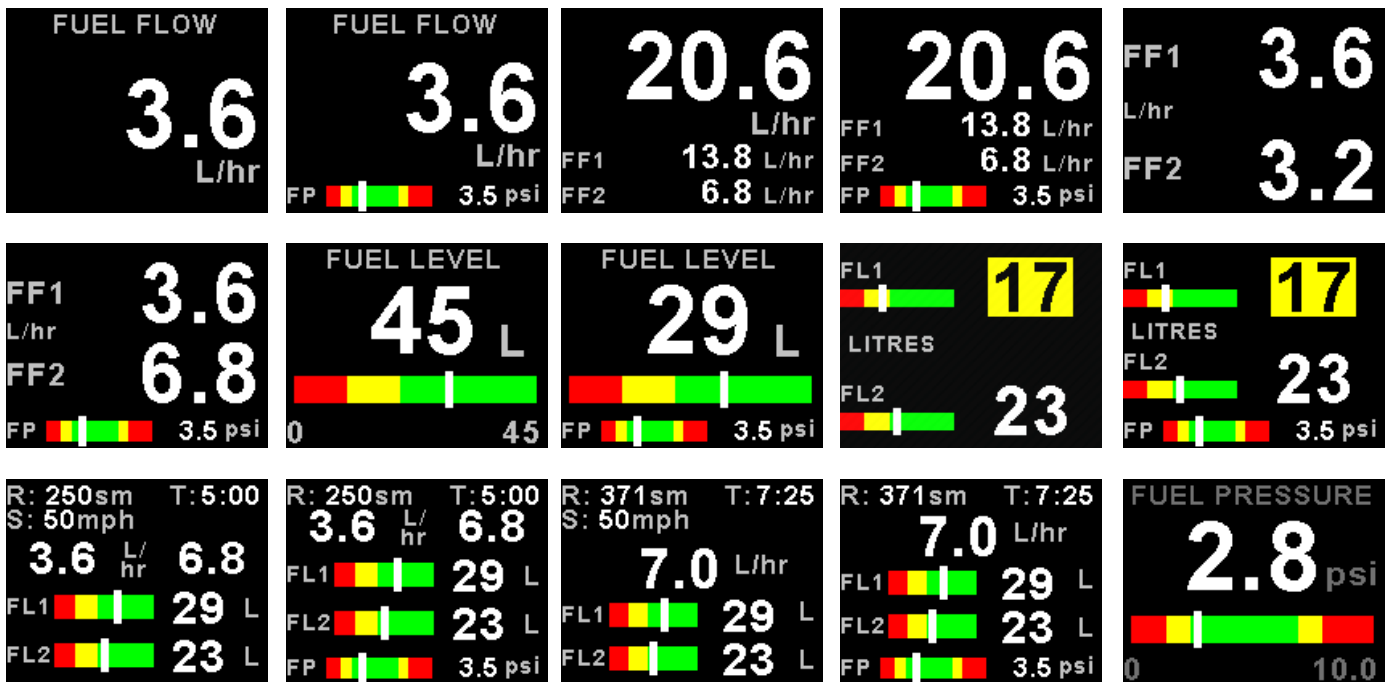
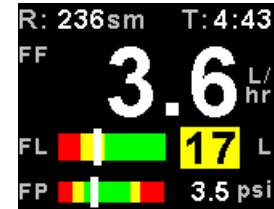
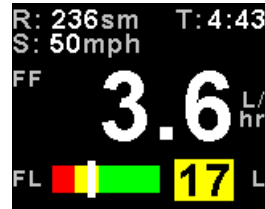

Introduction

The FF-4 is a 2 1/4" (57mm) sunlight readable color display instrument intended for efficient monitoring of fuel related information for single or dual fuel tanks. The FF-4 has many display configurations based on single/dual flow senders, single/dual level senders and a fuel pressure sender.

Full functionality is available with a fuel flow and level sender or only with a fuel flow sender using calculated fuel levels based on fuel usage. Differential fuel flow calculations are also supported for fuel return systems. Fuel injector systems are also supported. Standard automotive fuel level senders can be used, even with odd shaped tanks due to a comprehensive, multi-point calibration system. Most fuel flow senders can be used as the K-factor of the sender can be entered into the system for simple calibration.

MGL Avionics supplies a lightweight dual range fuel flow sender that is ideally suited for the FF-4. Fuel flow senders from other manufactures are equally suitable.

In addition, the FF-4 can use the actual ground speed from a RS232 NMEA enabled GPS receiver to determine fuel range.

The FF-4 can also be interfaced via the CAN bus to an external RDAC unit (Remote Data Acquisition Computer). This allows for easier installation as the RDAC unit is normally mounted in the engine compartment.

1 Features

- 1.8" high resolution 160x128, sunlight readable, wide viewing angle, 1000 cd/m2 TFT LCD display
- Advanced fuel computer with various modes of operation
- Supports single or dual fuel tanks
- The FF-4 can connect to one or two fuel flow senders, fuel level senders or fuel injectors
- The FF-4 can connect to a single fuel pressure sender
- Differential fuel flow calculations are also supported for fuel return systems
- The FF-4 has the ability to connect to a NMEA enabled RS232 GPS receiver for range based calculations. It can also accept a manually entered estimate cruising speed if a GPS is not available.
- Standard automotive fuel level senders can be used, even with odd shaped tanks due to a comprehensive, multi-point calibration system
- External RDAC (Remote Data Acquisition Computer) interfacing via the CAN bus
- Includes a RS232 serial output for interfacing to external equipment e.g dataloggers etc.
- Standard 2 1/4" (57mm) aircraft enclosure (can be front or rear mounted)
- Rotary control plus 2 independent buttons for easy menu navigation and user input
- An external output activates when an alarm condition has been reached
- Wide input supply voltage range of 8 to 30V DC with built in voltage reversal and over voltage protection for harsh electrical environments
- 1 year limited warranty

2 Layout

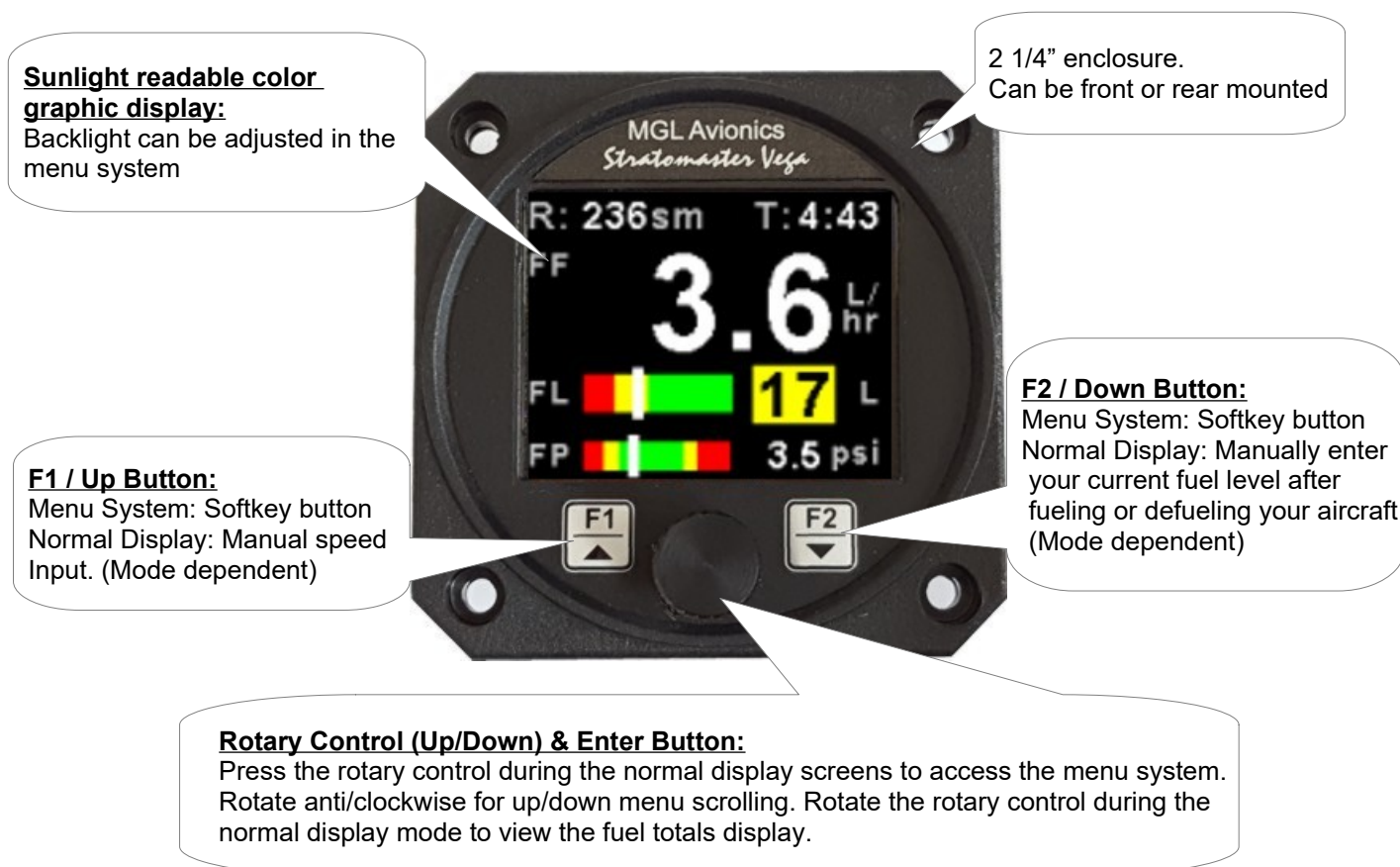

3 Main Displays

The FF-4 has various display screens depending on the mode selected.

- 3.1 Single fuel flow and calculated tank level (single tank)
- Single fuel flow and fuel level sender (single tank)
- Differential fuel flow and calculated tank level (single tank)
- Differential fuel flow and fuel level sender (single tank)
- Summed fuel flow and calculated tank level (single tank)
- Summed fuel flow and fuel level sender (single tank)

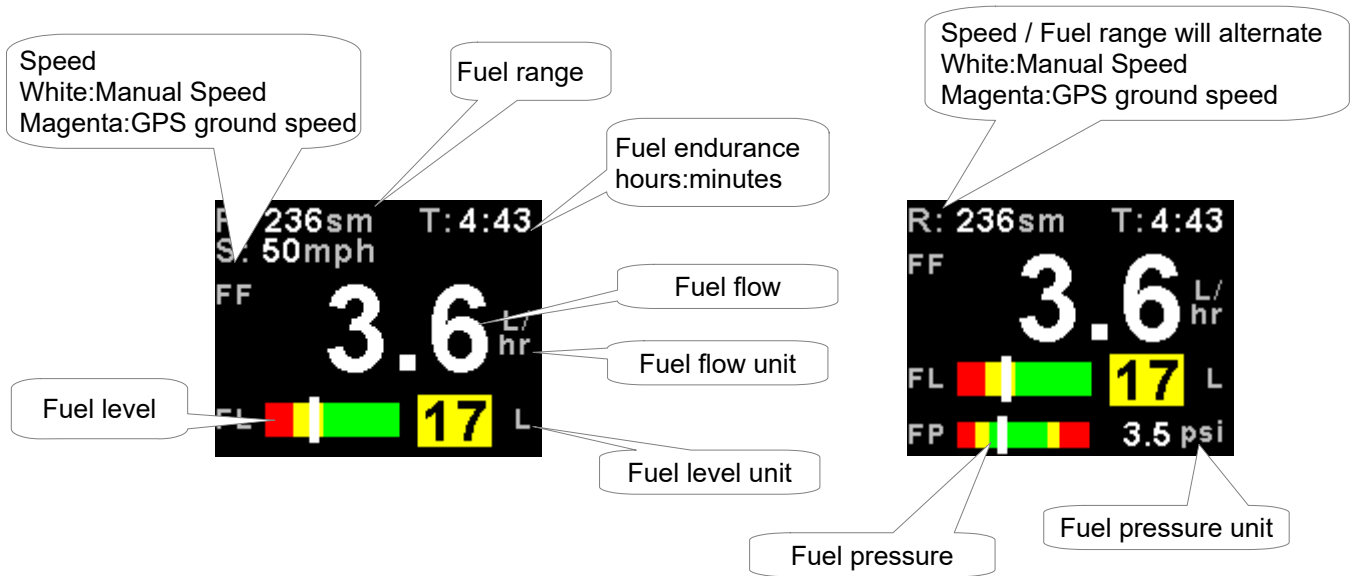

- 3.2 Dual fuel flow and calculated tank levels (dual tank)
- Dual fuel flow and dual fuel level senders (dual tank)

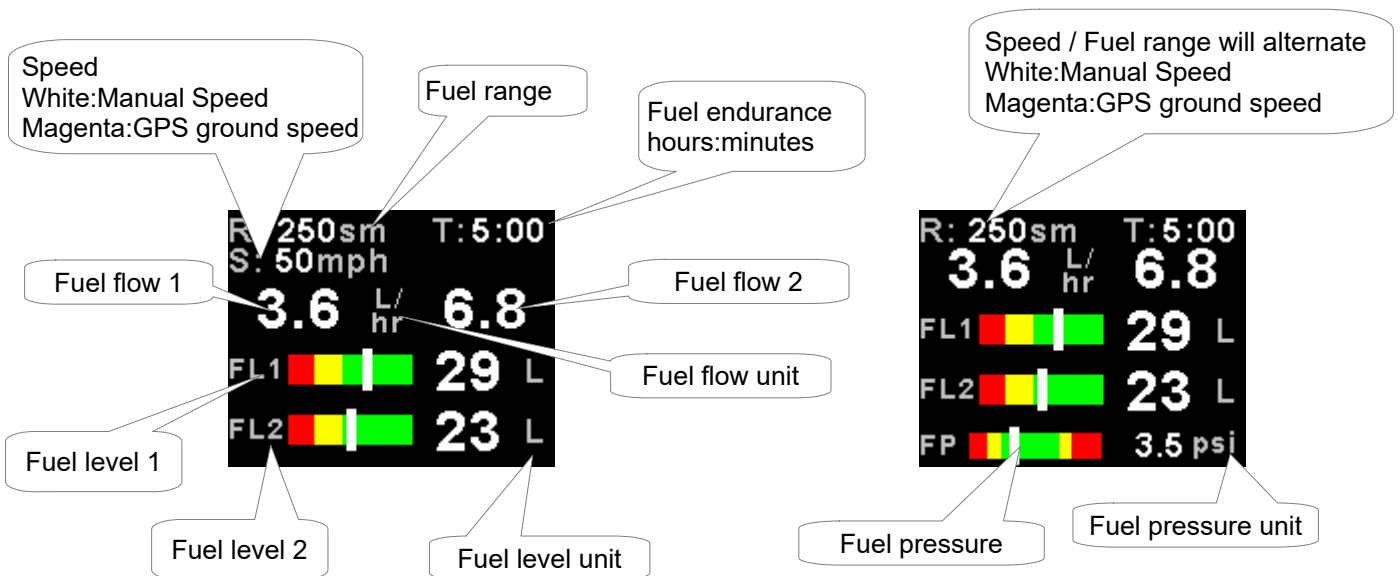

3.3 Single fuel flow and dual fuel level senders (dual tank)

Single fuel flow, single fuel level sender, single calculated tank

Differential fuel flow and dual fuel level senders (dual tank)

Differential flow, single fuel level sender, single calculated tank

Summed fuel flow and dual fuel level senders (dual tank)

Summed fuel flow, single fuel level sender, single calculated tank

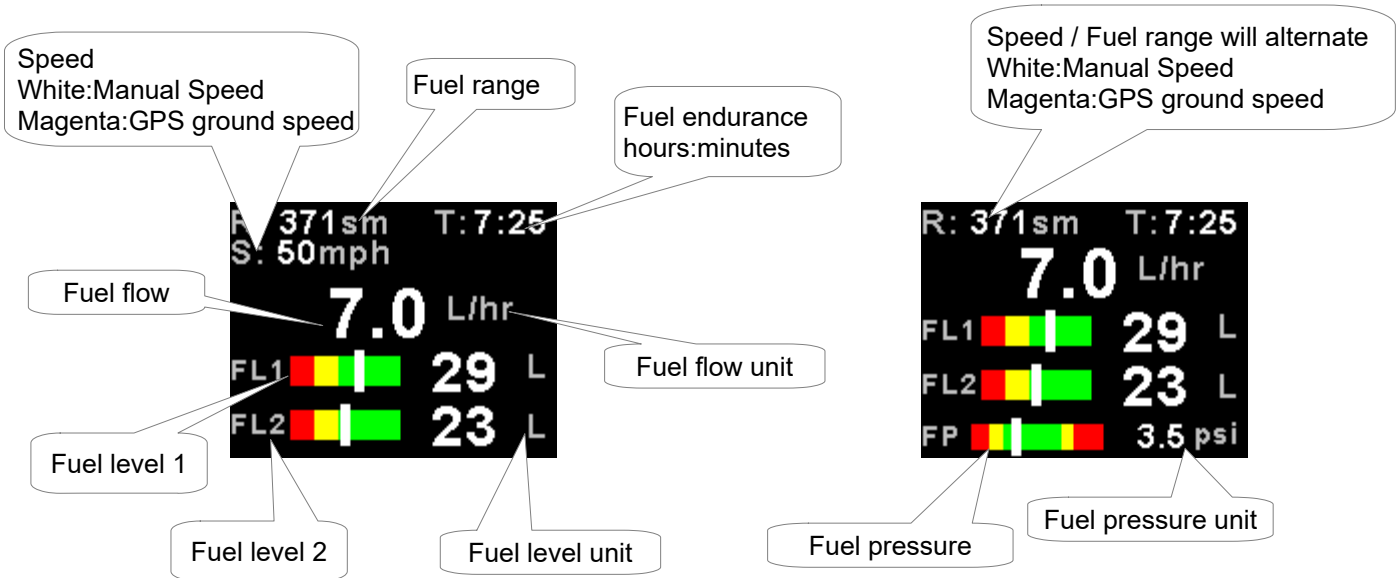

Single/Differential/Summed fuel flow, single fuel level sender, single calculated tank

These modes are nice for multiple fuel tanks whereby one or more tanks are difficult to insert level senders in. Potential problems such as those listed below can easily be diagnosed by doing side by side comparisons between a calculated and physical tank.

- Leaks in the fuel system
- Uneven drain of interconnected tanks
- Malfunction of the level sender
- Malfunction of the flow sender

Please note that the fuel flow deducts from the calculated tank only. Fuel range and fuel endurance will only be calculated if the corresponding fuel flow is setup with the corresponding calculated fuel tank e.g. fuel flow 1 and fuel tank 1.

3.4 Single fuel flow only indicator

This mode is displayed if either fuel flow 1 or fuel flow 2 is selected and no fuel level senders are selected.

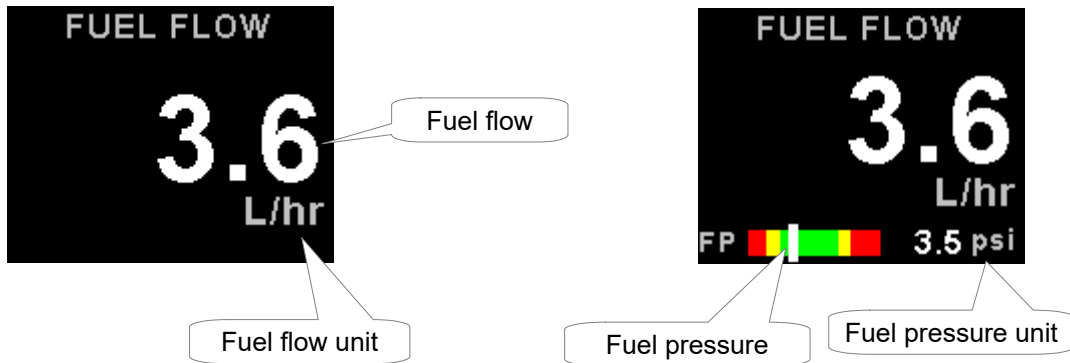

3.5 Dual fuel flow indicator

This mode is displayed if both fuel flow 1 and fuel flow 2 are selected and the fuel mode is selected for dual flow. Both fuel level senders are disabled.

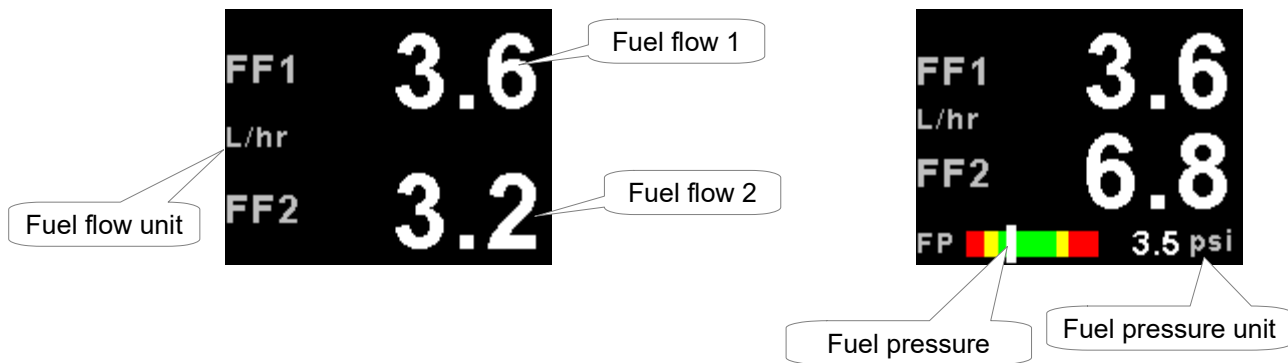

3.6 Single tank level indicator

This mode is displayed if either fuel level 1 or fuel level 2 is selected. Both fuel flow senders are disabled.

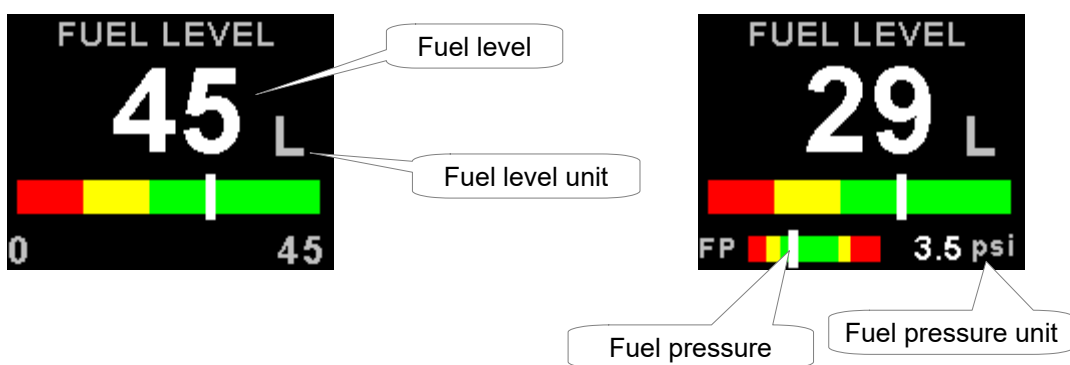

3.7 Dual tank level indicator

This mode is displayed if both fuel level 1 and fuel level 2 are selected. Both fuel flow senders are disabled.

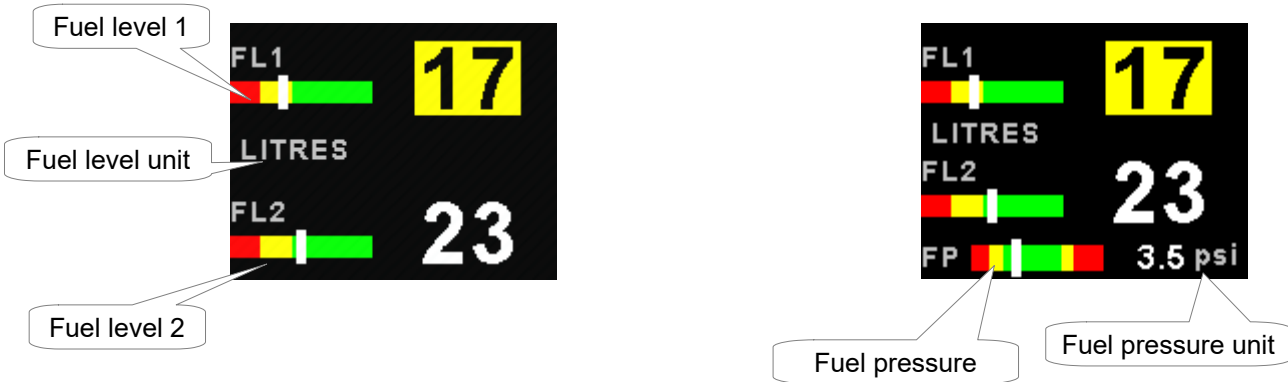

3.8 Differential/Summed fuel flow

This mode is displayed if both fuel flow 1 and fuel flow 2 are selected and the fuel mode is selected for either differential or summed.



3.9 Enter cruising speed (Mode dependent)



Press the F1 key during the main display screen to manually enter your aircraft's cruising speed. This value will be used to calculate the fuel range, i.e. how far you can fly with the remaining fuel at zero wind speed. For this calculation, your current remaining fuel, your current fuel flow and the speed entered here are taken into account. You can easily change the speed during flight to reflect changes in ground speed or cruising speed. Use this function with care and do not use it to extend your range. You must at all times have a secondary indication of available fuel. Note that flow senders and level senders may be subject to malfunction that may result in incorrect fuel levels being displayed or calculated. This function is only available in certain display modes.

3.10 Enter starting level of fuel tanks (Mode dependent)



Press the F2 key during the main display screen to manually enter your current fuel level after fueling or defueling your aircraft. This function is only available if you have a mode selected where fuel level is calculated from fuel flow. Press the F2 key again as a "quick fill button" to the full level.

Note: It is good airmanship to take into account a "silent" fuel reserve. For example, if you have a 50 Litre tank and you fill it, enter 40 or 45 Litres as your available fuel.

3.11 Fuel Totals (Mode dependent)

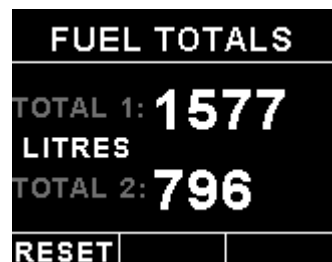

This display can be accessed by rotating the rotary control during the normal display mode. Press the F1/Up button when the fuel totals display is showing to reset the totalisers.

These are 2 independent accumulators for fuel tank 1 and fuel tank 2 that totalize the amount of fuel burn since the last time the accumulators were reset to zero.

3.12 Incorrect fuel setup message



The following message will be displayed if the FF-4 is incorrectly setup. For example if both fuel flow senders are disabled and a single/dual fuel level(s) are setup for calculated fuel tanks.

4 Menu System

Press the rotary control button during the normal display mode to enter the menu system. Use the rotary control to navigate through the menu system.

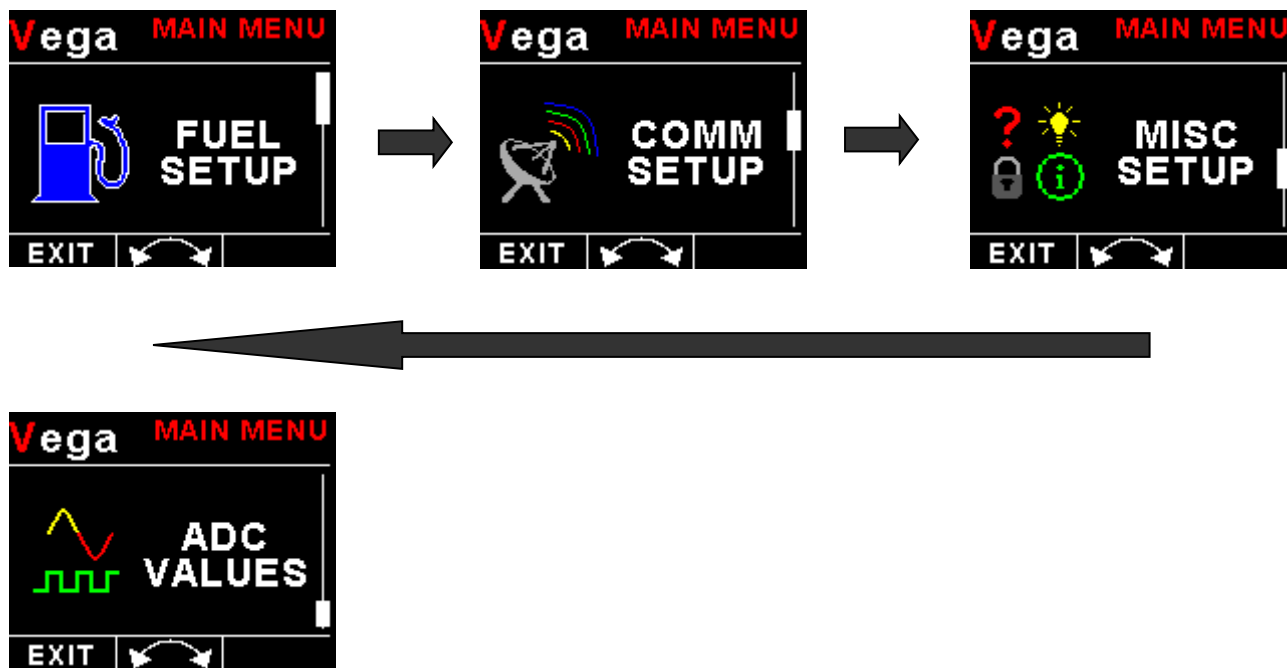

4.1 Exiting the menu system

Press the F1/Up button to exit the menu system when the "EXIT" soft key is shown. All changes made during navigation of the menu system will be saved in non-volatile memory upon exiting. The instrument will not save any changes if you remove power before exiting the menu system.

4.2 Fuel Setup



Unit:

Select your desired units for distance and fuel quantity. The following options are available:

L/sm: Litres and statute miles

G/sm: U.S. Gallons and statute miles

L/nm: Litres and nautical miles

G/nm: U.S. Gallons and nautical miles

L/km: Litres and kilometers

G/km: U.S. Gallons and kilometers

Flow 1:

Select if there is a fuel flow sender connected to the fuel flow 1 input.

K-Factor 1:

The K-Factor is the number of pulses generated by the fuel flow sender for one Litre of fuel. The dual range fuel flow sender supplied by MGL Avionics has a K-Factor of 7000 in the low flow mode (jet installed) and 1330 for the high flow mode (no jet installed). You can use the K-Factor to calibrate your fuel flow sender. See the installation section for more details on how to calibrate and install the fuel flow sender.

Flow 2:

Select if there is a fuel flow sender connected to the fuel flow 2 input.

K-Factor 2:

The K-Factor is the number of pulses generated by the fuel flow sender for one Litre of fuel. The dual range fuel flow sender supplied by MGL Avionics has a K-Factor of 7000 in the low flow mode (jet installed) and 1330 for the high flow mode (no jet installed). You can use the K-Factor to calibrate your fuel flow sender. See the installation section for more details on how to calibrate and install the fuel flow sender.

Mode:

Select if you want to measure fuel flow using a fuel flow sender or by using fuel injectors.

Injector:

Select whether the FF-4 fuel flow input is connected to the high or low side fired fuel injector.

Flow Mode:

If both fuel flow senders are selected then select if they are operating on individual fuel tanks (dual) or if they are operating in a supply/return type fuel system (differential) or in a summation system.

Tank 1 Setup

Select this menu item to setup the fuel level for fuel tank 1. See below for more details.

Tank 2 Setup

Select this menu item to setup the fuel level for fuel tank 2. See below for more details.

Fuel Press Setup

Select this menu item to setup the fuel pressure input. See below for more details.

NMEA Baud:

Select the Baud rate of your NMEA GPS receiver.

Data:

Select the data source of the fuel signals. Options include internal (using the internal electronics and Vega connector) or from an optional external RDAC unit.

RDAC Address:

Select the CAN address of the external RDAC unit.

4.2.1 Tank 1 / 2 Setup menu

Fuel level setup. (Only tank 1 setup is shown, follow the same steps for tank 2 setup)

**Tank:**

Select if fuel tank 1 has a physical fuel level sender connected to it or if the FF-4 must use a calculation based virtual fuel tank. If you do not want any fuel level information then set this parameter to off.

Tank Size:

Enter the size of the fuel tank in your system. It is recommended to choose a size that is slightly less than actual size so you can compensate for sender inaccuracies and give you a measure of reserve fuel.

Low Caution:

Enter the fuel level value for your fuel caution. Note that the fuel caution level will be displayed as a yellow bar on your fuel level display.

Low Alarm:

Select whether to turn the fuel tank 1 low level alarm on or off.

Low Alarm:

Enter your desired minimum fuel value that you would like to trigger the fuel low alarm. The fuel low alarm will result in the flashing of the fuel level display and remaining fuel readout. You can also connect a warning lamp to the external alarm output (see installation diagram). Note that the fuel low level will be displayed as a red bar on your fuel level display. This level is over and above your "silent" fuel reserve.

Add To Range:

Select whether this tank adds to the fuel range calculation

Calibrate Tank:

See section 4.2.2 on how to calibrate the fuel level senders.

Tank Filter:

Select the damping factor for the fuel level. A selection of none, low, med or high can be made.

Litre Res:

Select the resolution of the Litre unit. 1L or 0.1L

4.2.2 Calibrating the fuel level senders

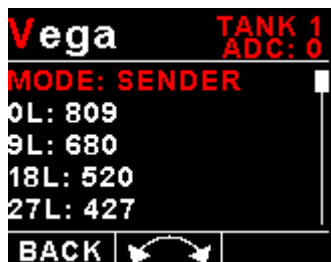

The fuel level sender needs to be calibrated before it can be used with this system. The calibration allows the system to learn the shape of your tank as well as any errors your fuel level sender or installation has.

Regardless of your use of a fuel flow sender, you can install a fuel level sender into your fuel tank. These level senders are inexpensive and are available as after market replacement fittings from a car spares outlet. We recommend the senders available from VDO.

Be aware that some makes of cheap level senders can prove troublesome, as the lever arms tend to be sticky. This prevents the floats from floating on the surface of the fuel at all times. As a consequence, this will lead to incorrect fuel level indication.

Adjusting calibration points automatically

Select "SENDER" for the mode menu item. Once you have installed a fuel level sender into your tank, make sure the float can travel all the way from empty to full position without hindrance of any kind. The calibration procedure should be carried out with your aircraft in flight attitude. This means you need to lift the tail if you have a tail-dragger or lift the nose wheel if you have a weight shift trike.

Calibration procedure

- Start the calibration procedure with an empty tank.
- Add five Litres of fuel (our reserve quantity) using a suitable measure. Make sure the measure is suitably accurate. This is now the "level sender reading at 0 Lt" position. Move the highlight to this position and wait until the sender reading has stabilized (You will see the sender ADC reading at the top). This could take up to a minute so have patience.

ENSURE THAT THE FLOAT IS NOT SUBMERGED AND IS FLOATING ON TOP OF THE FUEL LEVEL.

Should this number not react to changes of your level sender position, then you have a problem. Please check your wiring according to the installation section of this manual. You should expect the number to change in the region of at least 20 to 60 counts per calibration position. If the number does not change with fuel level or only changes a very small amount – check your installation. Something is not right!

- If you see the number changing then everything is well. Once it has stabilized and the highlight is on the 0 L position, press the rotary control to transfer the reading from the sender to the calibration point.
- Now you are ready for the next step. Add the required amount of fuel to get to the next level (In our case 9 Lt – this is 20% tank capacity). Once done, wait for the reading to stabilize and press the rotary control again after you have moved the highlight to the "9 L" position.
- Proceed in a similar manner until you have reached the last calibration position at 100% tank capacity.

You are done!

To finish your calibration, exit the calibration function.

The instrument uses the 6 calibration points to work out a correction curve that takes into account the tolerances of your fuel level sender and the shape of your fuel tank. This results in an incredibly accurate and usable fuel level display that far exceeds that available from ordinary dial type gauges.

Adjusting calibration points manually

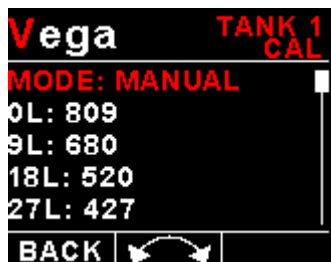

You may want to set individual calibration points manually. For example you may find that your fuel level is over reading at a specific fuel level. Correcting the tank level reading for this area can be simply done by adjusting the calibration point. You can do this by moving the float level with your hands to the desired position and then performing the calibration as outlined above, or you can use the manual option.

Select “*MANUAL*” for the mode menu item. Then highlight the point you want to change manually and press the rotary control. Use the up or down keys or the rotary control to adjust the value. Press the rotary control when done.

Note: The calibration positions may be edited by using the rotary control. This allows you, in theory, to copy calibration settings from one instrument to another. We however recommend that you do go through the calibration procedure even if the two aircraft are identical in all respects. Tolerances do exist and the calibration cancels these out. Accurate fuel level displays are a vital safety factor for an aircraft and a very useful feature for peace of mind during cross county flights.

Notes on Slope error



Sender value is a value determined by the FF-4. It is used to calculate fuel level, fuel endurance estimate and current range estimate. The fuel tank setup sender value can either increase in value as fuel is added or decrease in value if fuel is added. This is dependent on the type of fuel level sender used. However should the second reading be larger than the first reading all readings will have to be larger than the previous readings. Likewise should the second reading be smaller than the first reading all readings will have to be smaller than the previous reading.

If this is not the case the wording "Slope error" will be displayed. This could happen when fuel was removed instead of added between steps, no fuel was added between steps or when the fuel level sender was moved in the wrong direction e.g. moving the fuel level sender manually when it is not inserted in to the fuel tank. Determine the cause of the error if you should get a slope error message. If you do not know the cause of your error it is best to start from scratch. It should be remembered that accuracy in the fuel tank calibration is extremely important to enable your FF-4 to display the correct data.

4.2.3 Fuel Pressure Setup Menu

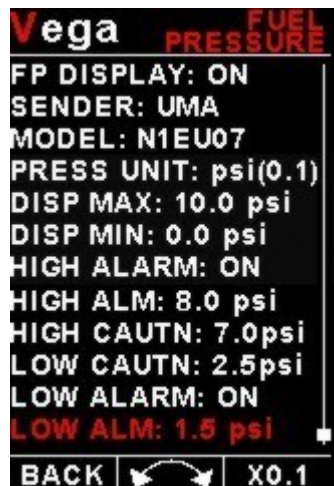

FP DISPLAY:

Select "ON" to display the fuel pressure reading on the main display.

SENDER:

Select the type of voltage sender used. Select "UMA" for UMA senders, "0.5-4.5V" for a 0.5V to 4.5V sender or "USER" for a custom 0-5V sender.

MODEL:

For UMA senders select the UMA model number.

If the "USER" pressure sender is selected

CALIBRATE SENDER:

If the sender type is set to "USER", then use this menu option to calibrate your pressure sender. See section 4.2.4 for more information.

Menu options for all sender types

PRESS UNIT:

Select whether you want to display the pressure in Bar, PSI or PSI(0.1). The PSI(0.1) is for low range pressure senders e.g. UMA 7PSI.

DISP MAX:

Select the maximum pressure that you want the bargraph to show. This can give you increased display resolution.

DISP MIN:

Select the minimum pressure that you want the bargraph to show. This can give you increased display resolution.

HIGH ALARM:

This enables or disables the manifold pressure high alarm.

HIGH ALM:

Enter the pressure threshold for when the high alarm must be activated. Any pressure above this value will activate the alarm.

HIGH CAUTN:

Enter the pressure value for the low caution. This is the lower value of the upper yellow band.

LOW CAUTN:

Enter the pressure value for the low caution. This is the upper value of the lower yellow band.

LOW ALARM:

This enables or disables the pressure low alarm.

LOW ALM:

Enter the pressure threshold for when the low alarm must be activated. Any pressure below this value will activate the alarm.

4.2.4 Calibrating the user defined pressure sender

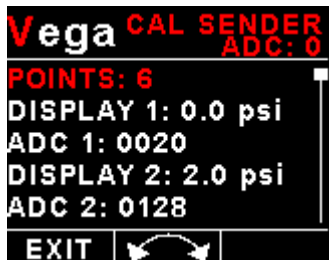

1. Enter the number of points that you want to calibrate.
2. Enter the display reading that you want to show when the sender is at that actual display reading.
3. Enter the ADC (analog to digital converter) reading that corresponds to this display reading. The ADC reading is shown at the top of the display if you are applying the actual stimulus from the pressure sender. You can also manually enter this value if the ADC value is known or pre-calculated.
4. Continue entering display and ADC values until all the points have been entered.
5. Verify the above calibration by checking the pressure display versus the actual applied sender stimulus.

4.3 COMM Setup (Communication Setup)



Serial Out:

Select "ON" to enable the RS232 serial output.

Unit Address:

Enter the unit address.

Baud Rate:

Select the desired baud rate of the serial output.

The transmission format is set to 8 data bits, No parity, 1 stop bit. The baud rate can be changed in the Communication Menu.

4.3.1 Protocol Format

STX, Address, Message type, Length, Data payload, Checksum, ETX

STX: Start of text (0x02)

Address: unsigned char (8bit), Unit address (range 0-255)

Message Type: unsigned char (8bit), Specifies the message type

Length: unsigned char (8bit), Length of the data payload (does not include the STX, Address, message type, checksum or ETX)

Data payload: Data

Checksum: unsigned char (8bit), XOR of all bytes starting from the unit address to the end of the data payload. The checksum is seeded with 0xa5. (does not include the STX or ETX)

ETX: End of text (0x03)

4.3.2 Data payload

Message type=11

Data Length=10 bytes

Output Rate=1Hz

Fuel Flow 1: Unsigned Int (16 bits), Fuel Flow 1 in 0.1Liters per Hour

Fuel Flow 2: Unsigned Int (16 bits), Fuel Flow 2 in 0.1Liters per Hour

Fuel Level 1: Unsigned Int (16 bits), Fuel Level 1 in Liters

Fuel Level 2: Unsigned Int (16 bits), Fuel Level 2 in Liters

Fuel Pressure: Signed Int (16 bits), Fuel pressure in 0.1psi

4.4 MISC Setup (Miscellaneous Setup)



Backlight:

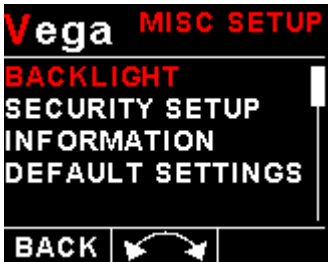

Select this menu option to adjust the backlight brightness.



Security Setup:



Select this menu option if you want to password protect the menu system.

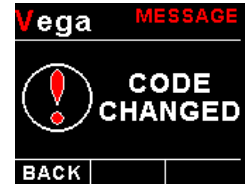
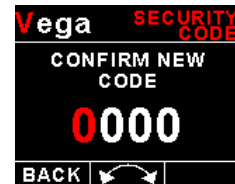

Information:

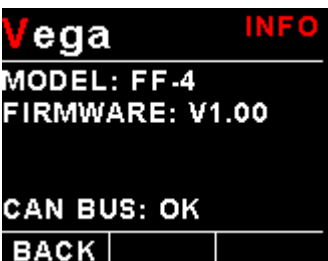

This menu option displays information about the unit.

Default Settings:

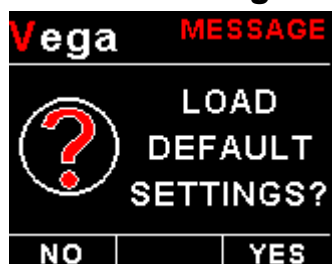

Select this menu option to reset all the settings to factory defaults.

4.5 ADC Values

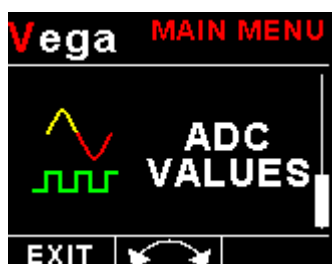

This menu displays the ADC values of the two fuel level and pressure sender.

5 Loading factory default settings



Press and hold the F1/Up button and rotary control during power up to load the pre-programmed factory default settings. The following screen will be displayed:

Factory default settings can also be loaded in the Miscellaneous setup menu.

6 Error Messages



Unit settings CRC error. Load default settings to restore to factory defaults. If the error message still persists then it could possibly be a non-volatile memory failure in which case the instrument will then have to be returned to the factory.



Internal flash CRC error. The instrument does a firmware check on the program when power is applied to the instrument . If the program is corrupt in any way then the internal flash CRC error will be displayed. Reload the instruments firmware and load default settings. If the error message still persists then it could possibly be an internal flash memory failure in which case the instrument will then have to be returned to the factory.



Fuel Data CRC error. The instrument could possibly have a non-volatile memory failure in which case the instrument will then have to be returned to the factory.



The red cross over the display means the FF-4 has lost communications with the external RDAC unit. Check the wiring between the FF-4 instrument and the RDAC unit. This error message is only available when the external RDAC is selected as the fuel data source.

7 Specifications

Operating Temperature Range	-20°C to 50°C (-4°F to 122°F)
Storage Temperature Range	-30°C to 80°C (-22°F to 176°F)
Power Supply	8 to 30Vdc SMPS (switch mode power supply) with built in 33V over voltage and reverse voltage protection
Current Consumption	Approx. 73mA @ 13.8V (backlight highest setting), 33mA @13.8V (backlight lowest setting)
Display	1.8" 160x128 pixel active matrix TFT display. 1000 cd/m ² Sunlight readable with anti-glare coating LED Backlight is user configurable
Alarm Output	Open collector transistor switch to ground Maximum rating 0.25A
ADC	12 bit
Dimensions	see Vega series dimensional drawing
Enclosure	2 1/4" (57mm) ABS, black in color, front or rear mounting. Flame retardant.
Weight	Approx. 120 grams (Instrument excluding cables)
Non-volatile memory storage	100000 write cycles
Fuel level input	Maximum voltage: 5V, 5mA maximum current
Fuel level senders supported	Any resistive type with common ground and capacitive probes with active voltage outputs up to 5V level (push pull or pullup)
Fuel flow senders	Supply 5V, 40mA maximum current. TTL level input with noise filter and Schmitt-trigger hysteresis. Required input voltage swing: less than 1.5V to more than 3.5V. Maximum input voltage range -5V to +18V
Fuel pressure senders	UMA N1EU07G(M): 7PSI (0.5Bar) for carbureted engine (Rotax) UMA N1EU35G(M): 35PSI (2.4Bar) for carbureted engine (Lycoming/Continental) UMA N1EU100G(M): 100PSI (6.9Bar) for injected (Lycoming/Continental) (M) is MGL modified senders
NMEA Baud rate	Selectable 1200 to 115200 baud

8 Operating the alarms

The alarm output can be used to switch an external alarm indicator. The external alarm switch is an open collector transistor switch to ground with a maximum rating of 0.25A DC. It is possible to wire the alarm contacts of several Stratomaster instruments in parallel should this be desired. To avoid false activation of the alarms, the alarm function is only active 10 seconds after the instrument has powered up.

9 Firmware Upgrading

The FF-4 can be upgraded in the field by connecting the RS232 port to a PC and running the firmware update program. **Note that only the RS232 port can be used to upgrade the firmware.**

Please see the Vega firmware upgrading document for more information.

10 Installation

10.1 Connection Diagram

The use of an external 1A fuse is recommended. Connect the supply terminals to your aircraft's power supply. The FF-4 can be used on both 12V and 24V without the use of any pre-regulators. Ensure that the supply voltage will not drop below 8V during operation as this may result in incorrect readings.

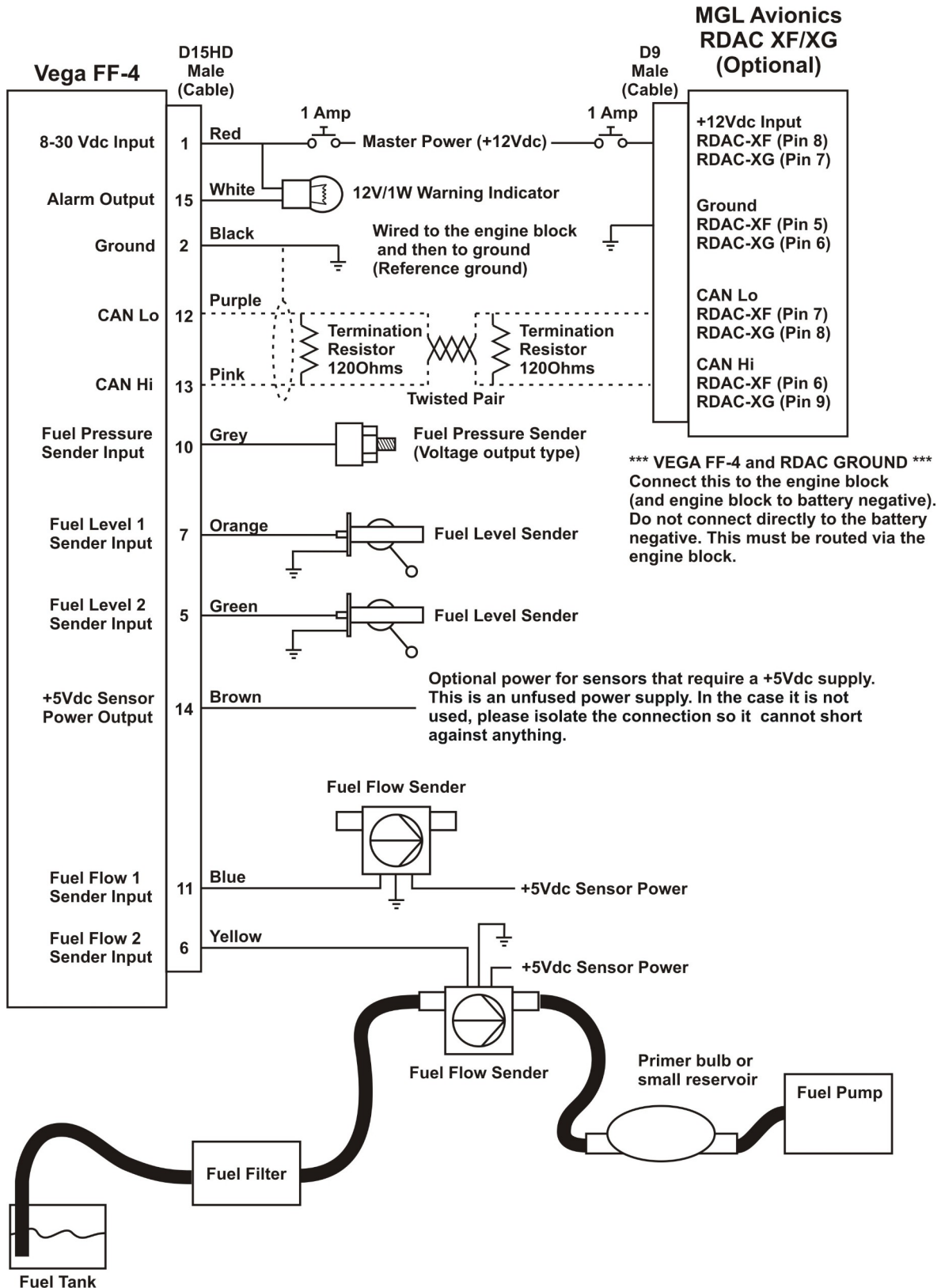

10.2 Fuel flow sender installation

The fuel flow sender allows the FF-4 to provide instantaneous readouts of hourly fuel usage, and both time and distance estimates on remaining fuel in flight. You can also verify the performance of your fuel pump during the pre-takeoff engine run up – a very valuable check! Further, it is possible to set up the instruments to calculate fuel remaining by subtracting fuel used from a value entered when you filled your tank(s). In this case you may omit the installation of the optional fuel level sender. **Please note that the installation of the fuel Flow sender should be done in such a fashion that dirt or debris from the fuel tank cannot lodge inside the flow sender. These will not block you fuel flow but may lead to the impeller inside the sender jamming. It is usually sufficient to mount the flow sender AFTER the fuel filter but before the fuel pump. It is a good idea to provide a small reservoir such as a primer bulb between the flow sender and the fuel pump.**

As indicated in the recommended installation drawing, it can be of advantage to install the flow sender in such a fashion that the inlet points slightly down and the outlet points slightly up. This prevents vapor from forming a bubble inside the flow sender. We strongly recommend mounting the flow sender in such a fashion that the impeller rests on only one bearing. This is achieved if you mount the sender such that the surface with the arrow faces upwards. Mounting the sender like this results in the best performance at low flow rates as only very little friction is present. The flow sender is delivered with a small jet that can be installed in the flow sender inlet. Installation of this jet is recommended for engines with fuel flow rates lower than about 30 Litres per hour. This would apply to most small two and four stroke engines. The FF-4 is shipped with the fuel flow sender calibration set for the jet installed. In a good installation you can expect about +/- 3% maximum flow reading error with this factor. You can calibrate the flow sender yourself to a higher degree of accuracy if you so desire.

Recommended procedure to calibrate the fuel flow sender:

Note: You must disable the fuel level sender if you have one installed, and enable the calculated fuel level sender.

1. Fill your tank exactly to a known level (for example 50 Litres).
2. Set your fuel level to 50 Litres.
3. Fly your aircraft for a period that you know will use approximately 20 Litres of fuel. The exact fuel burn is not important; just burn about 20 Litres of your fuel. At the end of your flight the instrument should give you a reading of how much fuel you have left – the reading should be about 30 Litres left.
4. Now place your aircraft in exactly the same position that you used when you first filled the tank and refill the tank to 50 Litres using a measuring jug. You should find that you need 20 Litres of fuel to refill to 50 Litres.
5. If you find that the instrument under or over reads the fuel used, you should perform a simple adjustment of the fuel flow sender calibration factor.

Example:

Actual fuel used: 21.5 Litres, FF-4 fuel burn calculated 29.7 Litres left in the tank. This means the FF-4 measured 50-29.7 = 20.3 Litres. We are under reading by 1.2 Litres.

Default calibration factor in Fuel setup menu = 7000.

Let the corrected calibration factor be X.

$$X = (20.3 * 7000) / 21.5$$

$$X = 6609.3$$

The closest setting you can enter as factor is 6609. Enter it into the unit and you are done!

Repeat the above procedure to verify that your flow sender is now reading correctly.

Please note:

Before you calibrate the flow sender ensure there are no problems with your installation. We find the senders are very accurate if everything is installed and working properly. If your fuel burn indication is out by a large amount you have a problem that you should not attempt to fix by fiddling with the calibration factor! Please ensure that no fuel vapor can be trapped inside the sender housing in the form of bubbles. Due to the low fuel flow rates the bubbles will prevent the tiny impeller from turning freely, you can verify the turning of the impeller. You should notice three dark spots that are just visible in the inside of the fuel flow sender. These are small magnets that are attached to the impeller. With fuel flowing you should see the magnets turning. The best defense against vapor bubbles is to install the flow sender in such a way that the bubbles can escape. The easiest way is to point the outlet slightly upwards and the inlet (with the jet) slightly downwards. Another possible problem is the fuel sender jet. When you install it, do not damage it. Use a drill bit of suitable diameter (5.5mm) to push the jet all the way, the opening of the jet must be just in front of the impeller.

YOU NEED TO APPLY SOME FORCE TO INSERT THE JET ALL THE WAY (about 24mm). THE JET MUST BE LOCATED RIGHT IN FRONT OF THE IMPELLOR. YOU CANNOT PUSH THE JET TOO FAR.

Using other Flow Senders

It is quite possible to use flow senders other than the MGL Avionics fuel flow sender. In this case ensure that the sender outputs a 5V TTL square wave or a similar signal. The FF-4 interface electronics will adapt to a variety of different voltages and pulse shapes as it contains a Schmitt-trigger input stage. The calibration factor can be entered in a wide range making the unit particularly suited to other flow senders. The supply output terminal for the sender provides a positive, regulated 5 volt output. This may be used to power the flow sender provided the sender will not draw more than 40 mA of current. Should your sender require a higher voltage or more current, you must supply the sender from a different power source. Exceeding the rating on the MGL Avionics fuel flow sender supply terminal can affect the operation on the unit negatively or even damage it. Some senders require a pull-up resistor to the 12V supply line. We find most installations of these senders require a 4K7 pull-up resistor.

Recommended Calibration Factors for the MGL Avionics dual range flow sender:

With jet installed = 7000. Recommended for flow rates below 30 Litres/hour maximum

Without jet installed = 1330. Recommended for flow rates above 30 Litres/hour

Please refer to the leaflet included with the flow sender for information on pressure drop versus flow rate, wetted materials etc.

It is your responsibility to ensure that the flow sender used is compatible with the fuels you intend using. We have found the MGL Avionics fuel flow sender to be very compatible with automotive fuels used in South Africa, many of which contain methanol. 100LL AVGAS also appears not to harm the sender in any way. We have exposed a sender continuously to our automotive fuels for the duration of two years without any noticeable ill effect on the sender. However, despite this MGL Avionics or its appointed agents cannot assume responsibility for any incident or damage, even loss of life by whatsoever cause connected with the fuel flow sender or the FF-4 instrument. Usage of this or other senders is your own sole responsibility.

If you do not agree with the above statement you must not use the fuel flow sender.

Note to Pilots: (Even though this is the installation manual)

You must always have a visual indication of the fuel level available, either by means of a sight glass, direct tank observation or a known, reliable secondary fuel level gauge. Fuel level indication by means of calculated fuel burn is subject to errors both by entering incorrect starting fuel levels as well as mechanical problems causing the flow sender impeller to turn too slowly, resulting in under reading fuel burn and thus over reading remaining fuel. As pilot in command of an aircraft it is your responsibility to ensure that you have sufficient fuel to reach your intended destination. Always ensure that you have a generous amount of reserve fuel and never use your reserve fuel except in an emergency if it is unavoidable.

10.3 Fuel level sender installation

The FF-4 permits the connection of one or two standard automotive fuel level senders. These senders can be obtained at automotive spares outlets at reasonable cost. When you choose a float level sender, ensure that you select a model that is sturdy and promises reliable and long lifetime. In particular, select a model that does not have any metal parts that can rust. The FF-4 can interface to a large variety of these fuel level senders. It does not matter if the sender resistance increases or decreases with the fuel level as long as it changes. The calibration procedure outlined in the “Fuel Setup” section describes in great detail the procedure to follow.

In essence, the calibration procedure will measure the resistance of the fuel level sender at various fuel levels and then work out the readings in between those known settings. Typical fuel level senders that can be used with the FF-4 have resistance ranges in the region of 100 ohms to 500 ohms. Connect the flange of the sender to the negative supply (ground). You can connect capacitive senders as well. These generally come in two types: The first emulates a normal resistive probe and is simple to connect and use as a result. The second type has a voltage level output. These can be used if the voltage can be set to a range of about 0-5V. Higher voltage levels will result in the instrument assuming a problem. The FF-4 supports one or two fuel tank level senders. You need to enable these in the “Fuel Setup” menu.

We recommend using VDO float based fuel level senders. Capacitive types can be used provided they have a voltage output not exceeding 5V. The level terminal has an internal 1K resistor pull-up to 5V. Please note that capacitive senders may exhibit large errors as they are very sensitive to the composition of the fuel used. We do not recommend using capacitive senders with automotive fuels for this reason.

Safety Hazard! Please take note:

Be careful when installing fuel level senders into fuel tanks. Ensure that the fuel tank is completely empty when you proceed with the installation. Ensure that the fuel tank is well ventilated and does not contain any fuel vapors – these are highly explosive when mixed with air. Ensure that at all times the ground connection (the connection of the fuel level sender mounting flange) is securely connected to the aircraft frame (in case of a metal frame) and to the negative terminal of the battery. In addition the negative terminal of the battery must at all times be connected to the supply ground terminal of the FF-4. Please note – this wiring is critical and must never break in flight. It would be possible to create electrical sparks in the fuel tank if your wiring is faulty or incorrect. The consequences of this can be imagined. This has nothing to do with the FF-4 itself but is a general hazard for any automotive fuel level sender installation. If you have no experience with electrical wiring, **PLEASE** delegate the task to a qualified automobile electrician or electronics technician. If you need to remove the FF-4, please first disconnect and secure the fuel level sender wire before disconnecting anything else.

10.4 Fuel pressure sender installation

Most fuel pressure senders tend to output a voltage level in proportion to the applied pressure. For these devices it is recommended to switch the pull-up resistor off (Dipswitch 3 OFF – Default setting).

UMA N1EU07G(M): 7PSI (0.5Bar) for carbureted engine (Rotax)

UMA N1EU35G(M): 35PSI (2.4Bar) for carbureted engine (Lycoming/Continental)

UMA N1EU100G(M): 100PSI (6.9Bar) for injected (Lycoming/Continental)

(M) is MGL modified senders

UMA Voltage output pressure sender (0 to 5V output)



Pinout:

Red or (Orange/White): +12V

White: Signal wire

Black or (Blue/White): Ground

Shield: Ground

Please see the UMA sender installation instructions for more information.

10.5 Fuel injector systems

Should you want to monitor fuel flow directly by means of measuring the fuel injector opening time, the connection as in the diagram below can be used. You can use either high or low fired injectors (most systems are low side fired as shown below). After you have connected the system as shown below you can proceed to set up the system. (don't forget that you need a connection from the FF-4 ground terminal to the engine block (at the same potential as the battery negative).

- Select high or low side fired injector in the Fuel Setup menu.
- Enable the flow sender in the Fuel Setup menu.
- Select a suitable K-factor in the calibration menu to give you correct rate of flow. A good starting value may be in the 1500-2000 range. Increase to lower indicated flow and decrease to have a larger indicated flow.

Flow through the injectors may not be 100% linear with switching times due to various effects. However, it is possible to obtain very good performance from this flow monitoring system if you keep the following in mind: Calibrate the K-factor so flow indication is accurate during cruise, the period your engine spends most of its active time at. Ensure that you have a correctly working fuel pressure regulator. The more constant your fuel pressure, the more accurate the flow indication.

Never use this or any other flow system as your only fuel level indication. This is not the intended purpose of a flow measuring system and this can be dangerous if for whatever reason incorrect flow is indicated.

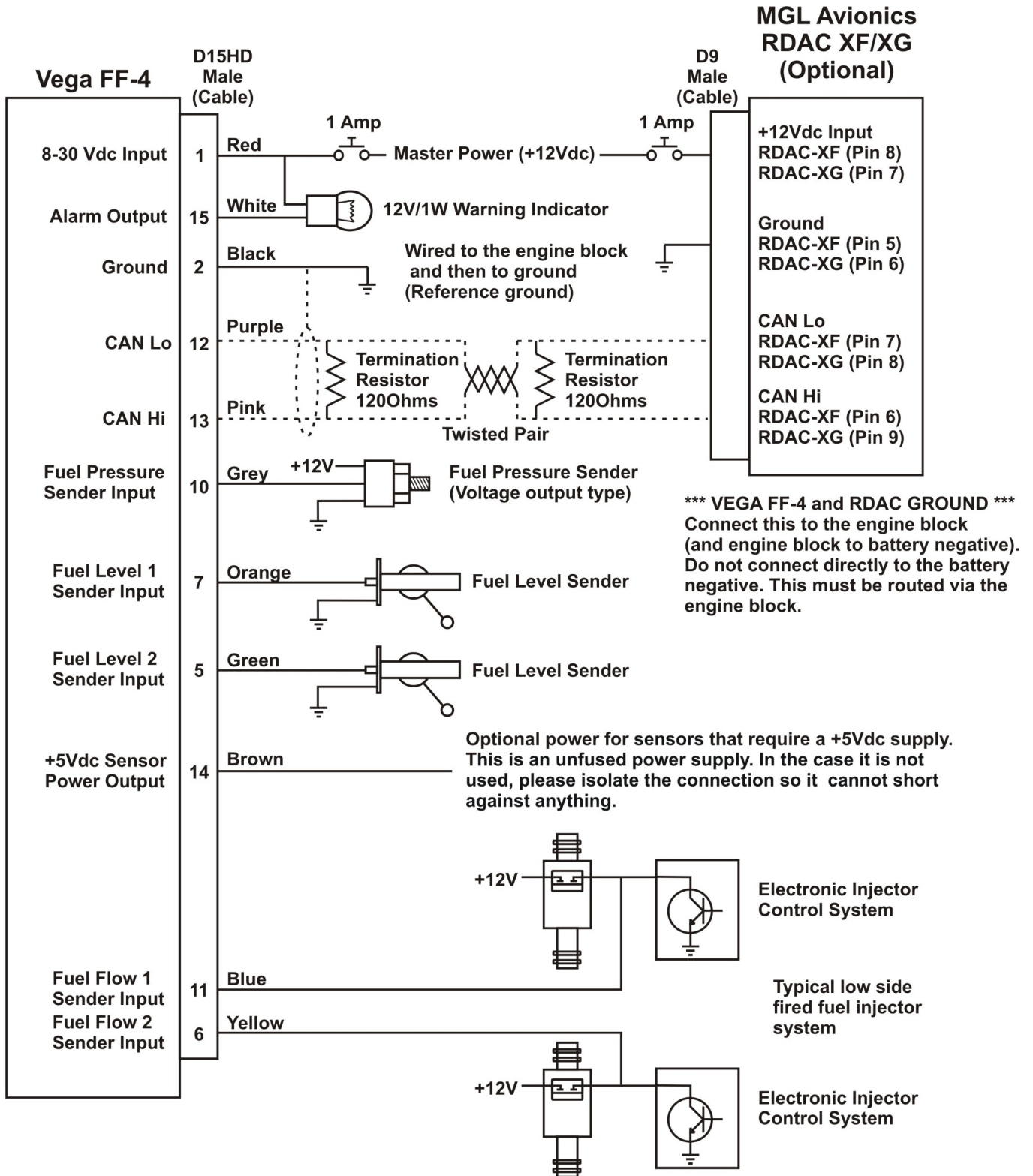

10.6 External RDAC (Remote Data Acquisition Computer) Connection

The FF-4 can use an external RDAC unit as the source for the fuel signals. Using an external RDAC may be beneficial as it will reduce the wiring from the engine compartment to the cockpit. Only the CAN High and CAN Low connections need to be made between the RDAC unit and the FF-4 in order for this to work. Select "RDAC" for the data source in the "FUEL SETUP" menu if using the external RDAC option. Please see the relevant RDAC installation manual for connection information.

10.7 FF-4 Cable connections

Main connector (D15HD connector: Unit Female, Cable Male)

D15HD Pin	Wire Color	Function
1	Red	8-30Vdc power via power switch / circuit breaker and fuse.
2	Black	Ground. Connect the ground to the engine block, and the engine block to the battery negative. Do not connect the FF-4 ground directly to the battery negative. This must be routed via the engine block.
3	-	RS232 Transmit data (Firmware upgrading)
4	White/Black stripe	RS232 Receive data (Firmware upgrading / NMEA GPS Input)
5	Green	Fuel Level 2 sender input
6	Yellow	Fuel Flow 2 sender input
7	Orange	Fuel Level 1 sender input
10	Grey	Fuel Pressure sender input
11	Blue	Fuel Flow 1 sender input
12	Purple	CAN Low (Used for optional external RDAC)
13	Pink	CAN High (Used for optional external RDAC)
14	Brown	+5Vdc Power out Sensor power
15	White	Alarm Output (Open collector)

10.8 Dipswitch settings

Use a small screwdriver to change the switch direction.

Fuel Level Dipswitch (Switch 1&2)

Some fuel level senders require a supply voltage. In those case the fuel level pull up resistor dipswitch must be in the "OFF" position.

Fuel Pressure Dipswitch (Switch 3)

Dipswitch 3 must be in the "OFF" position if using a voltage output fuel pressure sender.

Switch 4 must always be in the "ON" position.

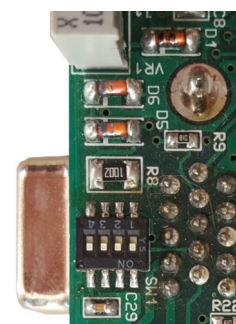

Dipswitch	Function
1	Fuel Level 1 Pull up
2	Fuel Level 2 Pull up
3	MUST be in the "OFF" position
4	MUST be in the "ON" position

11 Dimensions

Stratomaster Vega 2.25" (57mm) Dimensions

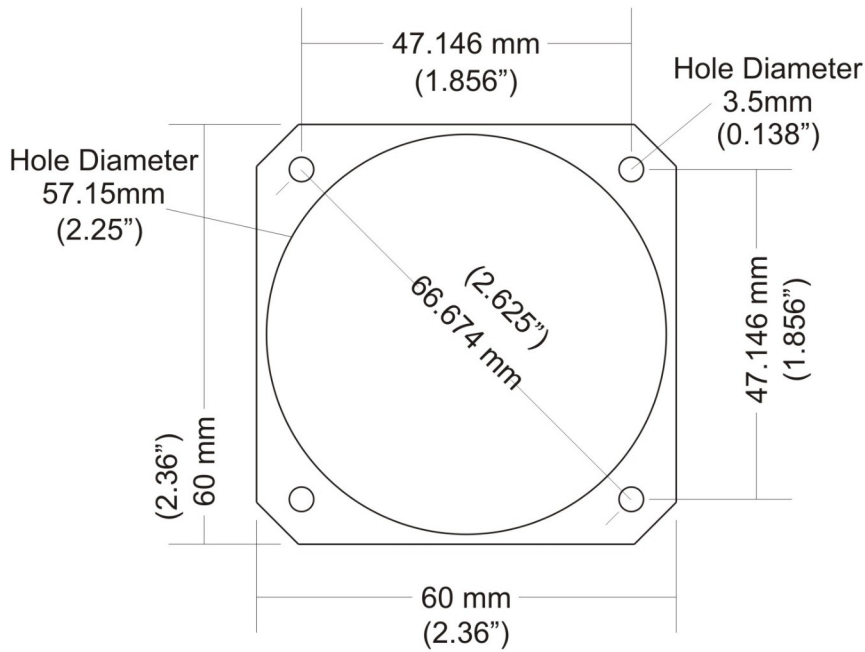

FRONT VIEW
3mm (0.118") mounting screws recommended

NOTE: 57.15mm (2.25") is a standard cutout, but due to manufacturing tolerances, 58mm (2.28") is found to be more desirable.

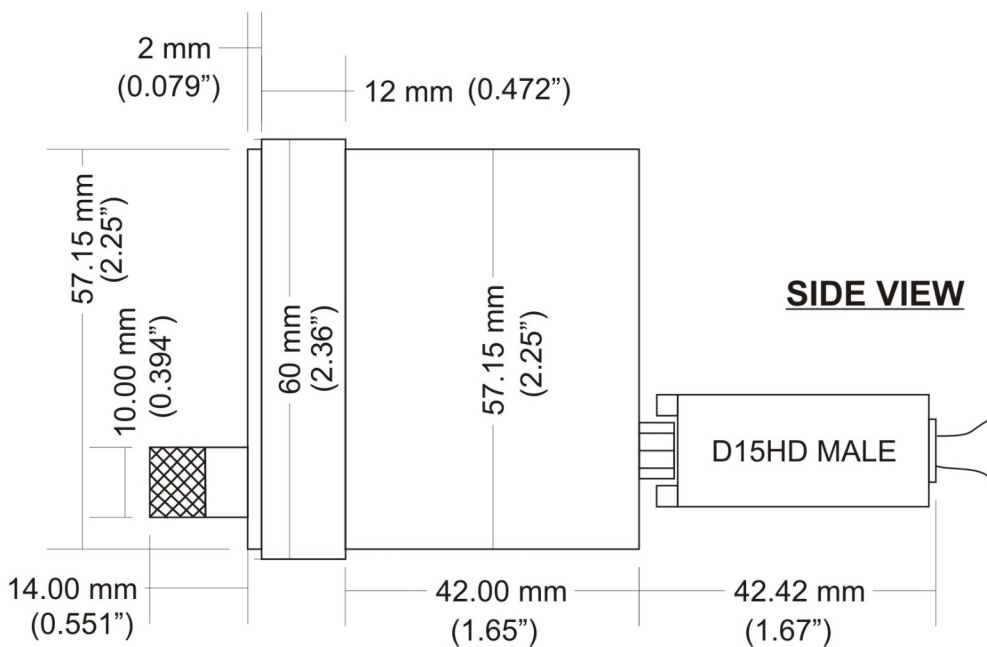

SIDE VIEW

12 Cleaning

The unit should not be cleaned with any abrasive substances. The screen is very sensitive to certain cleaning materials and should only be cleaned using a clean, damp cloth.

Warning: The FF-4 is not waterproof, serious damage could occur if the unit is exposed to water and/or spray jets.

13 Warranty

This product carries a warranty for a period of one year from date of purchase against faulty workmanship or defective materials, provided there is no evidence that the unit has been mishandled or misused. Warranty is limited to the replacement of faulty components and includes the cost of labor. Shipping costs are for the account of the purchaser.

Note: Product warranty excludes damages caused by unprotected, unsuitable or incorrectly wired electrical supplies and or sensors, and damage caused by inductive loads.

14 Disclaimer

Operation of this instrument is the sole responsibility of the purchaser of the unit. The user must make themselves familiar with the operation of this instrument and the effect of any possible failure or malfunction.

This instrument is not certified by the FAA. Fitting of this instrument to certified aircraft is subject to the rules and conditions pertaining to such in your country. Please check with your local aviation authorities if in doubt. This instrument is intended for ultralight, microlight, home built and experimental aircraft. Operation of this instrument is the sole responsibility of the pilot in command (PIC) of the aircraft. This person must be proficient and carry a valid and relevant pilot's license. This person has to make themselves familiar with the operation of this instrument and the effect of any possible failure or malfunction. Under no circumstances does the manufacturer condone usage of this instrument for IFR flights.

IMPORTANT NOTICE:

You must make your own determination if the products sold by MGL Avionics are safe and effective for your intended applications. MGL Avionics makes no representations or warranties as to either the suitability of any of the products we sell as to your particular application or the compatibility of any of the products we sell with other products you may buy from us or anywhere else, and we disclaim any warranties or representations that may otherwise arise by law. Also, we offer no specific advice on how to install any of the products we sell other than passing along anything that may have been provided to us by the manufacturer or other issues. If you are in need of further information or guidance, please turn to the manufacturer, FAA Advisory Circulars and guidance materials, the Experimental Aircraft Association, or other reputable sources.

Continuing development sometimes necessitates specification changes without notice.

Other instruments in the *Stratomaster Vega* series

AHRS-1	Artificial Horizon and Magnetic Compass Indicator
AHRS-3	Self contained Artificial Horizon and Magnetic Compass Indicator
ALT-5	Altimeter and Vertical Speed Indicator (VSI)
ASI-4	Airspeed Indicator (ASI)
ASV-1	Altimeter, Airspeed (ASI) and Vertical Speed Indicator (VSI)
EMS-1	Engine Monitoring System
FF-4	Fuel Computer
INFO-1	Information Display (G-Force meter, UTC and Local Time, Slip Indicator, Outside Air Temperature (OAT), Battery Voltage, Current and charge display, Flight Timer & Flight Log, Stopwatch, Countdown Timer and Alarm)
MAG-1	Magnetic Compass Indicator
MAP-3	Manifold Pressure and RPM Indicator
RPM-1	Universal Engine / Rotor RPM Indicator
TC-4	4 Channel Thermocouple (EGT/CHT) Indicator
TP-3	4 Channel Universal Analog Input (Pressure/Temperature/Current/Volts) Indicator