

Blaze ASV-2

Altimeter, Airspeed and Vertical Speed Indicator

Operating Manual – English 1.07

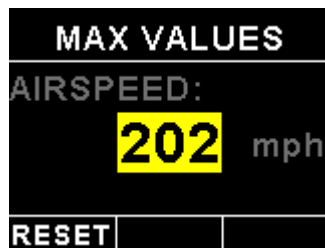
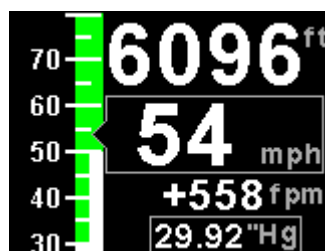
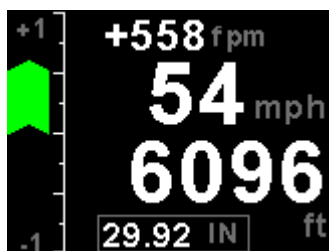

Introduction

The ASV-2 is a 3 1/8" (80mm) sunlight readable encoding altimeter, airspeed and wide range vertical speed indicator.

The altimeter contains an internal high accuracy 24 bit digital altitude sensor which calculates altitude from -1500 ft up to a maximum of 35000 ft. The ASV-2 outputs various formatted RS232 serial data protocols compatible with serial input transponders such as that from Garmin, Magellan, Northstar, Trimble, Microair etc. The altimeter can display altitude in feet or meters and local pressure can be set in millibars or inches of mercury

The VSI indicator can be displayed in either feet/minute (ft/min) or meters/second (m/s). The VSI can be calibrated by the user once the instrument has been installed in the aircraft.

Airspeed is based on the pressure generated by a pitot tube system and a static port is provided as well for use by high speed aircraft. The ASV-2 can measure airspeed from 20mph to 250mph (Version 1), 20mph to 350mph (Version 2) and 20mph to 320mph for the ASV-2HS (High Speed version). All are well suited to slower aircraft due to very good sensitivity and linearity at low air speeds. Airspeed can be indicated in statute miles per hour (mph), kilometers per hour (km/h) or nautical miles per hour (kts). The ASV-2 also provides a programmable Vs and Vne airspeed alarm output. ASI sensitivity can be calibrated by the user to cater for errors caused by pitot tube placement.

In addition, the ASV-2 provides an encoder test function, flight timer since takeoff and records the maximum airspeed reached. The ASV-2 provides a parallel Gillham code interface when used in conjunction with the MGL Avionics CNV-ALT.

Please note that the ASV-2 Version 2 replaces both the ASV-2 Version 1 and the ASV-2HS (High speed) unit.

1 Features

- Large 2.6" high resolution 320x240, IPS (fully viewable in all directions), sunlight readable color LCD display
- A choice of 3 different display screens with either an Altitude, VSI or Airspeed tape
- An internal high accuracy 24 bit digital altitude sensor calculates altitude from -1500 ft up to a maximum of 35000 ft (-457m to 10668m)
- The ASV-2 outputs various formatted RS232 serial data protocols compatible with serial input transponders such as that from Garmin, Magellan, Northstar, Trimble, Microair etc.
- Provides a parallel Gillham code interface for transponders when used in combination with the MGL Avionics CNV-ALT
- Built in encoder test function
- The altimeter can display altitude in feet or meters
- User settable altimeter bug when using the altimeter tape display
- Local pressure can be set in millibars or inches of mercury
- Contains a wide range VSI indicator from +/-20 ft/min to as high as +/-10000 ft/min
- VSI units can be in feet/minute (ft/min) or in meters/second (m/s)
- The ASV-2 measures airspeed from 20mph to 250mph (Version 1)
- The ASV-2 measures airspeed from 20mph to 350mph (Version 2)
- The ASV-2HS (High Speed version) measures airspeed from 20mph to 320mph
- Both units are well suited to slow aircraft due to very good sensitivity and linearity at low air speeds
- Includes a flight timer since takeoff
- Airspeed units can be set to miles per hour (mph), kilometer per hour (km/h) or nautical miles per hour (kts)
- Contains a programmable Vs and Vne airspeed alarm output
- Provides a 50 entry flight log that stores duration of each of the last 50 flights. The flight timer can either be started automatically or by using a front push button
- Records maximum airspeed reached in permanent memory
- Includes a RS232 serial output for interfacing to external equipment e.g dataloggers, CNV-ALT etc.
- Standard 3 1/8" (80mm) aircraft enclosure (can be front or rear mounted)
- The LED backlight can automatically adjust to the ambient light, or it can be manually adjusted in the menu system
- Rotary control plus 2 independent buttons for easy menu navigation and user input
- Wide input supply voltage range of 8 to 30V DC
- 1 year limited warranty

2 Layout

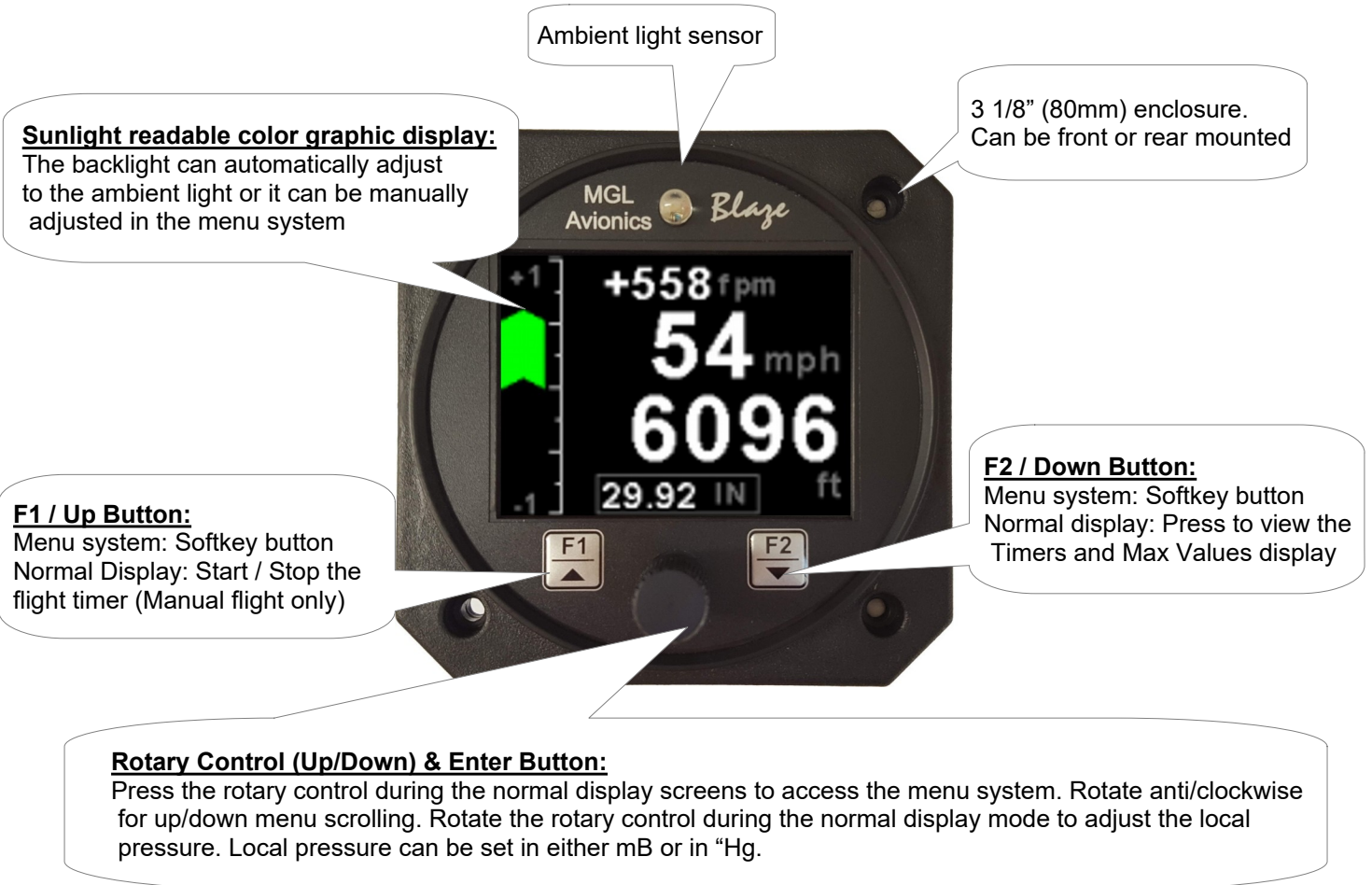

3 Main Display

The ASV-2 has 3 different display screens. The main display screen can be selected by using the "TAPE" menu option.

3.1 VSI "TAPE" Display

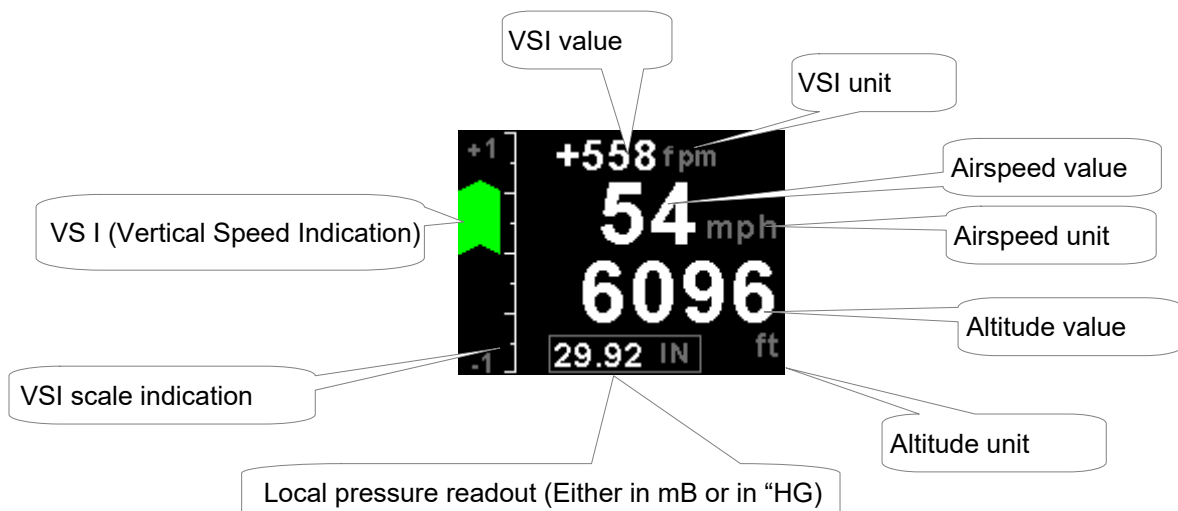

3.2 Altitude "TAPE" Display

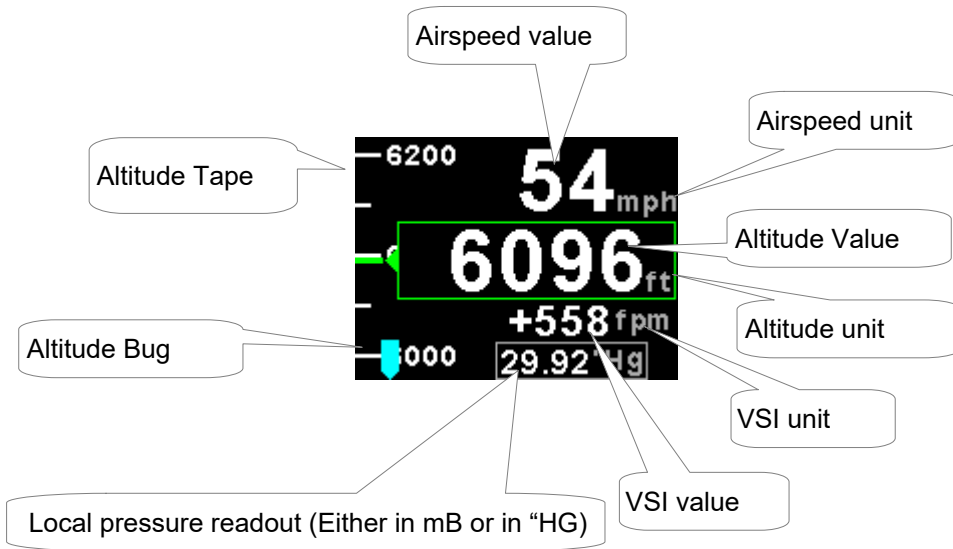

3.3 Airspeed "TAPE" Display

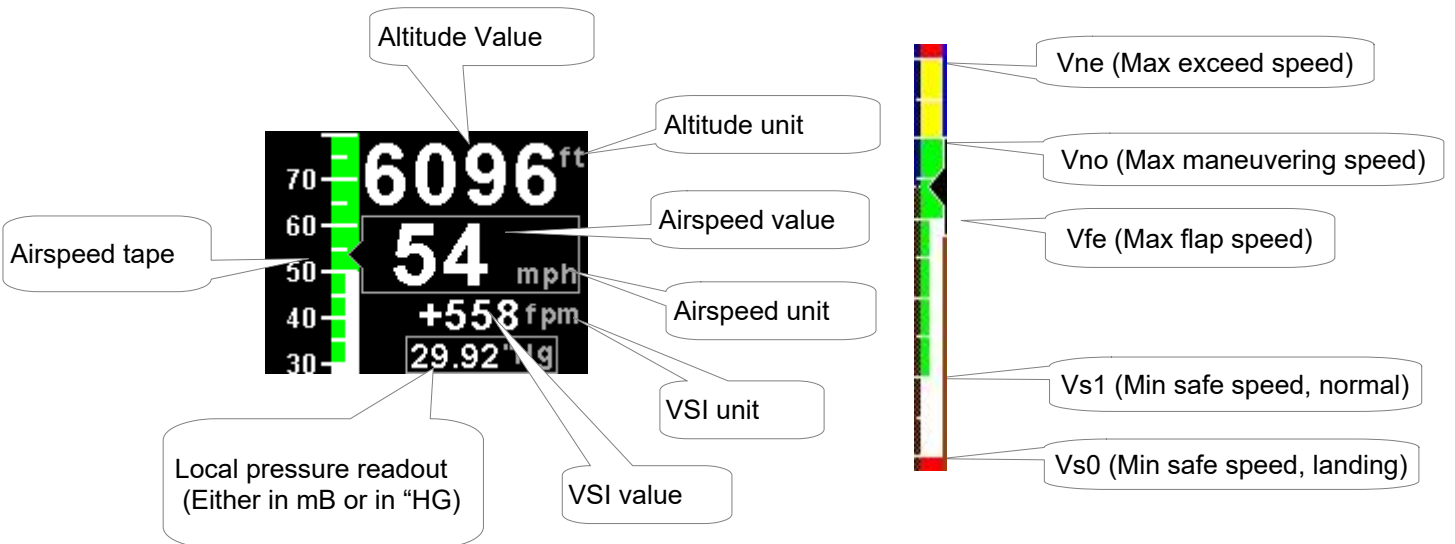

3.4 Start / Stop flight display



Press the F1/Up button during the normal display mode to manually start/stop a flight. This key is only active if the ASV-2 is setup to select the manual flight option under the "TIMERS" setup menu.

3.5 Altitude Bug

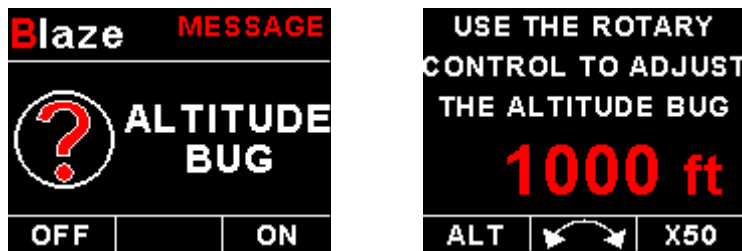

Press the F1/Up button during the altitude "TAPE" display to access the altitude bug setting screen. Press the F1/Up key to set the altitude bug to the current altitude or use the rotary control to adjust the altitude bug. Press the F2/Down key to change the increment / decrement unit to 50 or 500. Press the rotary control to exit and save.

The bug will be yellow when in the display screen and cyan when either above or below the limits of the display.

3.6 Timers display



This display can be accessed by pressing the F2/Down button during the normal display mode.

3.7 Maximum Airspeed display

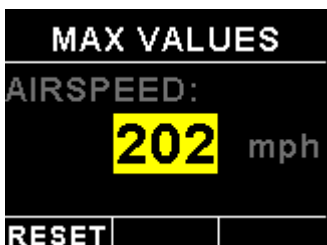

This display can be accessed by pressing the F2/Down button during the normal display mode. Press the F1/Up button when the max values display is showing to reset the maximum values to the current airspeed.

Note: The maximum airspeed is stored in non-volatile memory and is recalled on power-up.

4 Menu System

Press the rotary control button during the normal display mode to enter the menu system. Use the rotary control to navigate through the menu system.

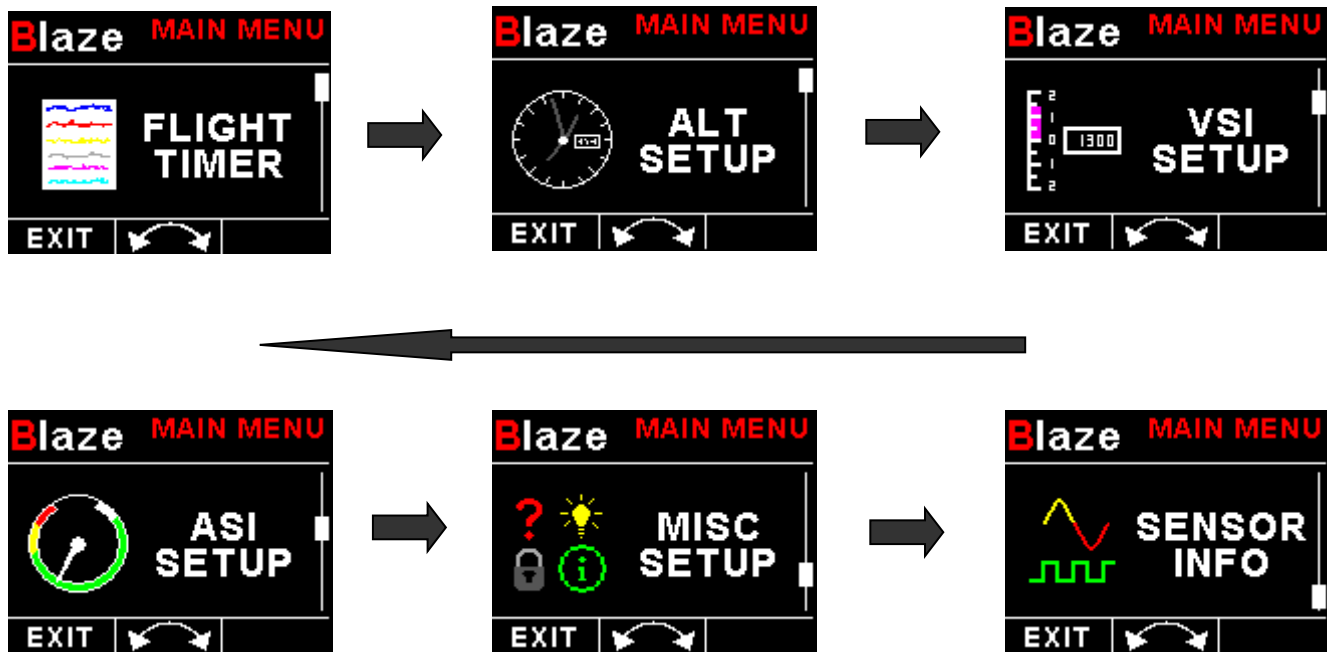

4.1 Exiting the menu system

Press the F1/Up button to exit the menu system when the "EXIT" soft key is shown. All changes made during navigation of the menu system will be saved in non-volatile memory upon exiting. The instrument will not save any changes if you remove power before exiting the menu system.

4.2 Flight Timer



View Flight Log:



Use the rotary control to view the next flight log entry.

Erase Flight Log:

Use this function to erase the flight log stored in the ASV-2.

Flight:

Select whether you want the ASV-2 to automatically detect a flight or whether the pilot must press the F1/Up button to start/stop a flight. We recommend you select automatic flight detection.

T/O Airspeed:

This menu option is only shown if the "DETECT" flight mode is selected. Enter the takeoff airspeed threshold that you want the flight timer to start incrementing.

The flight ends if the airspeed value falls below the preset value for 30 seconds. This ensures that touch-and-goes will not result in the end of a flight and a logbook entry.

4.3 ALT Setup (Altitude Setup)



Altitude Unit:

Select if you want the altitude displayed in ft (feet) or m (meters).

Pressure Unit:

Select if you want the local pressure displayed in mb (millibars) or "Hg (inches of mercury).

Resolution:

Select the resolution of the altitude value, a selection of 1,10,25 or 100 ft or m can be selected.

Position:

Select whether you want the altitude display on the top or on the bottom of the main display (VSI Tape display only).

ALT Calibrate

This section allows for the calibration and fine tweaking of the altitude value. Before you begin, ensure that your calibrated and certified reference is set to the local pressure of 1013.25mB (29.92"Hg). The ALT-5 altitude value in ft (referenced to 1013.25mB (29.92"Hg)) is displayed in the top right hand corner of the display. All calibration must be done in feet.

The combined adjustments cater for both the altitude sensors offset and gain. Only start the calibration sequence once the instrument has been running for a minimum of 10 minutes.

Start the altitude calibration with the "CAL FACTOR" and make sure the "CAL GAIN" value is set to 100.00%.



Cal Factor:

This is the pressure sensor offset in 0.1mB increments. Adjust your static pressure to be close to sea level pressure. The exact altitude is not important and can be up to several hundred feet. Adjust the calibration factor so the altitude readout in the top right hand corner of the display agrees with your pitot static test set.

Cal Gain:

Once you are satisfied that the low level altitude "CAL FACTOR" is correct, apply a static pressure that will result in an altitude between 20000 and 30000 ft. Adjust the "CAL GAIN" until the altitude readout in the top right hand corner of the display agrees with your pitot static test set

NOTE: Adjusting the "CAL GAIN" also changes the low level altitude calibration achieved when adjusting the "CAL FACTOR". Please recheck your low level altitude calibration and adjust if necessary. Recheck your altitude readout at the higher altitude, and if needed slightly adjust the "CAL GAIN" again. Repeat the process until you are satisfied with both the "CAL FACTOR" altitude and the "CAL GAIN" altitude.

Tape:

Select the desired display tape (Altitude, VSI or airspeed). The main display screen will change according to this selection.

Serial Out:

Select "ON" to enable the RS232 serial altitude output. This formatted serial RS232 message can be directly interfaced to various RS232 serial input transponders. If a parallel Gillham output is required then a CNV-ALT can be purchased from your MGL Avionics distributor to convert the RS232 output to a parallel Gillham output.

Prot:

Select the protocol of the serial RS232 output message. The protocol can be selected between GARMIN AT, Magellan, Northstar / Garmin, Trimble / Garmin, MGL Avionics and Microair UAV. Please note that the baud rate is automatically adjusted according to which protocol is selected. The output format is as follows. The message contains the current pressure altitude with a fixed reference to 1013.25mB (29.92 inches mercury). All protocols use 8 databits, no parity, and 1 stop bit. The message is outputted once a second.

Protocol	Baud Rate	Message format	Example
Garmin AT	1200	#AL, space, +/-, five altitude digits right justified zero padded, T+25, checksum, carriage return The checksum is a simple modulo 256 sum of the binary values of the individual characters. The checksum is sent as two characters in hexadecimal format	#AL +02372T+25DF[CR]
Magellan	1200	#MGL, +/-, five altitude digits right justified zero padded, T+25, checksum, carriage return The checksum is a simple modulo 256 sum of the binary values of the individual characters. The checksum is sent as two characters in hexadecimal format	\$MGL+02372T+2513[CR]
Northstar, Garmin	4800	ALT, space, five altitude digits right justified zero padded, carriage return	ALT 02372[CR]
Trimble, Garmin	9600	ALT, space, five altitude digits right justified zero padded, carriage return	ALT 02372[CR]
MGL Avionics	9600	ALT, +/-, five altitude digits right justified zero padded, 1013.25mB (29.92" Hg) referenced, C, +/-, five altitude digits right justified zero padded (corrected to local	ALT+02372C+02372L1013+0000XCA[CR]

		pressure), L, local pressure setting in millibars,+/-, four digit VSI reading right justified zero padded in ft/min, X, checksum, carriage return The checksum is a simple modulo 256 sum of the binary values of the individual characters. The checksum is sent as two characters in hexadecimal format	
Microair UAV	9600	STX,a,=, five altitude digits right justified zero padded, ETX	[STX]a=02372[ETX]
Infiniteq	57600	See Infiniteq protocol format below	
STX=0x02 ETX=0x03 CR=0x0D			

Infiniteq protocol format:

STX, Address, Message type, Length, Data payload, Checksum, ETX

STX: Start of text (0x02)

Address: unsigned char (8bit), (0x01)

Message Type: unsigned char (8bit), (0x06)

Length: unsigned char (8bit), Length of the data payload (does not include the STX, Address, message type, checksum or ETX), (0x0e)

Data payload:

Altitude: Signed Long (32 bit), Altitude in feet (Referenced to 1013.25mB)

Altitude: Signed Long (32 bit), Altitude in feet (Corrected to local pressure)

Local Pressure: Unsigned Int (16 bit), Local pressure setting in millibars

Vertical Speed: Signed Int (16 bit), Vertical Speed in ft/min

Airspeed: Unsigned Int (16 bit), Airspeed in mph

Checksum: Unsigned char (8bit), XOR of all bytes starting from the unit address to the end of the data payload. The checksum is seeded with 0xa5. (does not include the STX or ETX)

ETX: End of text (0x03)

Test Alt Encoder:

This is a handy function to test the ASV-2 transponder interface once the installation has been completed. The serial output will output specific altitudes which can then be used to test the serial RS232 output and the parallel gillham output if using a CNV-ALT converter. The ASV-2 will resume the normal output of the indicated altitude upon exiting the test function.

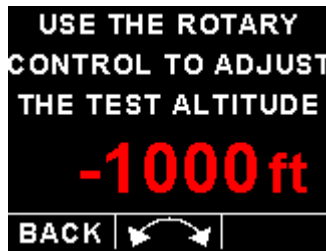

The following codes are outputted:

Altitude	D4	A1	A2	A4	B1	B2	B4	C1	C2	C4
-1000ft	0	0	0	0	0	0	0	0	1	0
-900ft	0	0	0	0	0	0	0	1	1	0
-700ft	0	0	0	0	0	0	1	1	0	0
-400ft	0	0	0	0	0	0	1	0	1	1
-200ft	0	0	0	0	0	1	1	0	0	1
800ft	0	0	0	0	1	1	0	0	0	1
2800ft	0	0	0	1	1	0	0	0	0	1
6800ft	0	0	1	1	0	0	0	0	0	1
14800ft	0	1	1	0	0	0	0	0	0	1
30800ft	1	1	0	0	0	0	0	0	0	1

Each altitude reporting code line must be tested for integrity of connection if at any time the aircraft connections to the transponder or altitude data source have been removed and reconnected. Integrity of the connections may be verified by performing a test of mode C function of the transponder system.

Warning: Do not use this function while in flight as incorrect altitude information will be sent to the transponder.

4.4 VSI Setup (Vertical Speed Indicator Setup)



VSI Display:

Select if you want the VSI to be displayed.

VSI Unit:

Select if you want the VSI to be displayed in "*ft/min*" (feet/minute) or "*m/s*" (meters/second).

Scale:

Select the VSI scale most suited for your aircraft.

VSI Cal:

This is a function that is used to calibrate your VSI to read exact rates of climb or decent. This function works as a percentage of initial reading. The default setting for this function is 100%. Increasing this value increases the VSI reading and decreasing the value decreases the reading.

Suggested VSI calibration method

After you have installed the instrument, perform a calibration flight. This should be done in very calm conditions. Turbulence and thermal activity will make accurate calibration impossible. Many areas have ideal conditions during early mornings or late afternoons. Place the instrument in ft/min for ease of calibration. Take your aircraft to a few thousand feet above ground and start a glide with a low power setting. Take a stopwatch and when the glide is stable (stable VSI reading) start the stopwatch. Take note of your altimeter reading at the same time. Continue the stable glide for one minute exactly. After the minute has finished, take another reading of your altimeter.

Example:

VSI reading during stable glide: -400 ft/min

Start altitude: 2500 ft.

End altitude: 2050 ft.

In the above example the VSI is under reading by about 12%. Set your VSI calibration to 112% to cancel out the error.

Tape:

Select the desired display tape (Altitude, VSI or airspeed). The main display screen will change according to this selection.

4.5 ASI Setup (Airspeed Setup)



Zero ASI Sensor:

This setup allows your instrument to measure the zero airspeed reading of the airspeed sensor and set a calibration value internally for this. This is equivalent to some mechanical airspeed indicators that have an adjustment to set the needle to zero when the aircraft is not moving. You would use this function occasionally if you see an airspeed reading when the aircraft is at rest. This may be caused by aging of the built in pressure sensor or related electronics. When this function is performed make sure that there is no air flow into the pitot tube as this would result in an incorrect internal calibration.



ASI Unit:

Select if you want the ASI to be displayed in mph (statute miles per hour), km/h (kilometers per hour) or kts (nautical miles per hour).

ASI Filter:

This function can be used to select the signal filter time constant. Selections are "NONE", "FAST" or "SLOW". This selection influences the rate at which your ASI can change its reading. If you have an installation that suffers from strong turbulence at the pitot tube, select "slow". If you have a very clean airflow in front of the pilot tube you can select "fast" which will give you a faster response to airspeed changes.

ASI Span:

Select the maximum airspeed that you want the airspeed tape to display. This can give you increased display resolution.

ASI In View:

Adjust this setting to set the amount of tape to view. For example, setting this value to 30% and your "ASI SPAN" to 250 will result in the tape showing 75 on the display at a time.

Vne Speed: (Max Exceed Speed)

Enter your maximum speed your aircraft should not exceed.

Vno Speed: (Max Maneuvering Speed)

Enter your maximum maneuvering speed.

Vfe Speed: (Max Flap Speed)

Enter the maximum speed that is permissible with the flaps extended.

Vs1 Speed: (Min Safe Speed, Normal)

Enter your minimum safe speed for normal flight of your aircraft

Vs0 Speed: (Min Safe Speed, Landing)

Enter your minimum safe speed for landing your aircraft

Vs Alarm:

This enables or disables Vs Alarm.

Vne Alarm:

This enables or disables the VNE alarm.

Cal:

During the factory calibration a factor has been determined and entered here that will give you accurate airspeed, provided your pitot tube is not influenced by pressure effects caused by airflow around your airframe. The calibration is displayed in % of the reading, you can increase or decrease the reading if required to help cancel out under or over reading of the airspeed indicator on your aircraft.

Position:

Select whether you want the airspeed display on the top or on the bottom of the main display (VSI Tape display only).

Tape:

Select the desired display tape (Altitude, VSI or airspeed). The main display screen will change according to this selection.

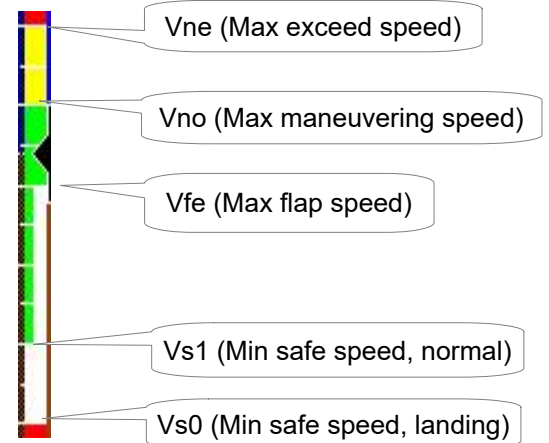

4.6 MISC Setup (Miscellaneous Setup)



Backlight:



Select manual or automatic backlight control.

Use the rotary control in manual mode to adjust the backlight brightness.



Allow 3 seconds for the display to adjust to the ambient lighting conditions when using the automatic backlight mode. The display will set the backlight to the dim setting if the ambient light is less than the threshold setting, alternatively the display will set the backlight to the bright setting if the ambient light is greater than the threshold setting. The ambient light received is shown as the ADC value in the top header. Use this value to set the threshold value.

Security Setup:



Select this menu option if you want to password protect the menu system.



Information:

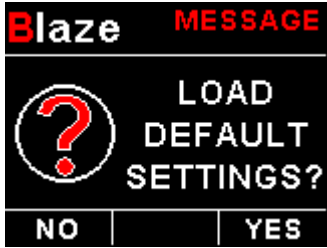

This menu option displays information about the unit.

Default Settings:

Select this menu option to reset all the settings to factory defaults.

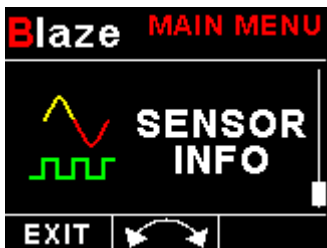
4.7 Sensor Info

This menu displays information about the altitude and airspeed sensors.

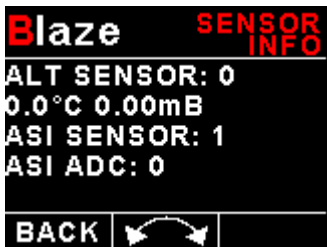
**5 Loading factory default settings**

Press and hold the F1/Up button and rotary control during power up to load the pre-programmed factory default settings. The following screen will be displayed:

Factory default settings can also be loaded in the Miscellaneous setup menu.

6 Error Messages



UNIT
SETTINGS
CRC ERROR

Unit settings CRC error. Load default settings to restore to factory defaults. If the error message still persists then it could possibly be a non-volatile memory failure in which case the instrument will then have to be returned to the factory.



CALIBRATION
CONSTANTS
CRC ERROR

Calibration constants CRC error. The instrument could possibly have a non-volatile memory failure in which case the instrument will then have to be returned to the factory.



INTERNAL
FLASH
CRC ERROR
UNIT:123456
CODE:654321

Internal flash CRC error. The instrument does a firmware check on the program when power is applied to the instrument . If the program is corrupt in any way then the internal flash CRC error will be displayed. Reload the instruments firmware and load default settings. If the error message still persists then it could possibly be an internal flash memory failure in which case the instrument will then have to be returned to the factory.



MAX VALUES
CRC ERROR

Max Values CRC error. Load default settings to restore to factory defaults. If the error message still persists then it could possibly be a non-volatile memory failure in which case the instrument will then have to be returned to the factory.

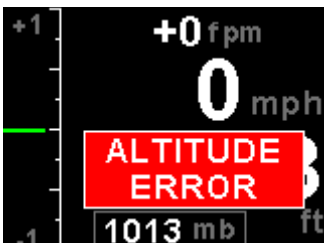

+1
+0 fpm
0 mph
ALTITUDE
ERROR
-1
1013 mb ft

Altitude sensor error. The instrument could have a faulty altitude sensor in which case the instrument will then have to be returned to the factory.

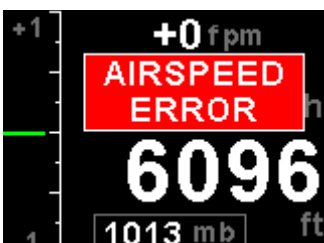

+1
+0 fpm
AIRSPEED
ERROR
-1
6096
1013 mb ft

Airspeed sensor error. The instrument could have a faulty airspeed sensor in which case the instrument will then have to be returned to the factory. (Digital airspeed sensor models only)

7 Specifications

Operating Temperature Range	-10°C to +55°C (14°F to 131°F)
Storage Temperature Range	-20°C to 80°C (-4°F to 176°F)
Humidity	<85% non-condensing
Power Supply	10 to 30Vdc
Current Consumption	Approx. 125mA @ 12V (backlight highest setting), 50mA @12V (backlight lowest setting)
Display	2.6" 320x240 IPS color LCD display Minimum 600cd/m2 brightness Sunlight readable with anti-glare coating LED Backlight can be set to automatic or can be manually adjusted
Alarm Output	Open collector transistor switch to ground Maximum rating 0.25A
Dimensions	see Blaze series dimensional drawing
Enclosure	3 1/8" (80mm) ABS, black in color, front or rear mounting. Flame retardant.
Weight	Approx. 160 grams (Instrument excluding cables)
Non-volatile memory storage	100000 write cycles
Altitude sensor ADC resolution	24 bit
Altimeter range	-1500ft to 35000ft (-457m to 10668m)
Altitude units	ft or m
Baro Correction Range (inHg)	28.00 to 31.00 "Hg
Baro Correction Range (mB)	946 to 1050 mb
Pressure units	"Hg or mb
VSI range	+/-20ft/min to +/-10000ft/min
VSI units	ft/min or m/s
Airspeed sensor ADC resolution	ASV-2 Version 1: 12 bit ASV-2 Version 2: 24 bit ASV-2HS: 13.5bit
Airspeed range	ASV-2 Version 1: 20mph to 250mph ASV-2 Version 2: 20mph to 350mph ASV-2HS (High Speed version): 20mph to 320mph
Airspeed resolution	1 mph
Measurement accuracy	+/- 2mph
Serial Port	RS232 voltage levels
Calibration interval	1 Year

As with any instrument, regular zeroing is suggested to achieve maximum performance.

8 Operating the alarms

The alarm output can be used to switch an external alarm indicator. The external alarm switch is an open collector transistor switch to ground with a maximum rating of 0.25A DC. It is possible to wire the alarm contacts of several Stratomaster instruments in parallel should this be desired. To avoid false activation of the alarms, the alarm function is only active 10 seconds after the instrument has powered up.

9 Firmware Upgrading

The ASV-2 can be upgraded in the field by connecting the RS232 port to a PC and running the firmware update program. **Note that only the RS232 port can be used to upgrade the firmware.**

Please see the Blaze firmware upgrading document for more information.

10 Installation

Connect a pitot tube to the “pressure port” and if required connect the static port.

Connect the static port to a suitable static air pressure line. If you have a slow aircraft or an aircraft where the internal cabin pressure does not change during flight and is equivalent to the outside air pressure you may find that it is not required to connect a static port. Most small aircraft such as ultralights or microlights do not require a connection to a static port. In these cases, simply leave the static port open. Ensure however that the static port does not receive pressurized air due to the forward movement of the aircraft. Be especially critical of your pod or panel if you do not use a static port. Any build up of a pressure differential due to ram air or suction can lead to large errors of the indicated airspeed and altitude. Static ports are usually mounted at a strategic position on the rear side of the aircraft fuselage for faster, pressurized aircraft.

The ASV-2 pressure ports take 4mm ID tubing. Use hose clamps to fasten the hose onto the ASV-2 pitot and static ports.

The ASV-2 allows you to calibrate the airspeed reading. This is done under the “AIRSPEED SETUP” menu item. The main reason for this is to be able to remove errors introduced due to the airflow around your aircraft which may have an effect on your pitot tube pressure.

10.1 Connection Diagram

The use of an external 1A fuse is recommended. Connect the supply terminals to your aircrafts power supply. The ASV-2 can be used on both 12V and 24V without the use of any pre-regulators. Ensure that the supply voltage will not drop below 8V during operation as this may result in incorrect readings.

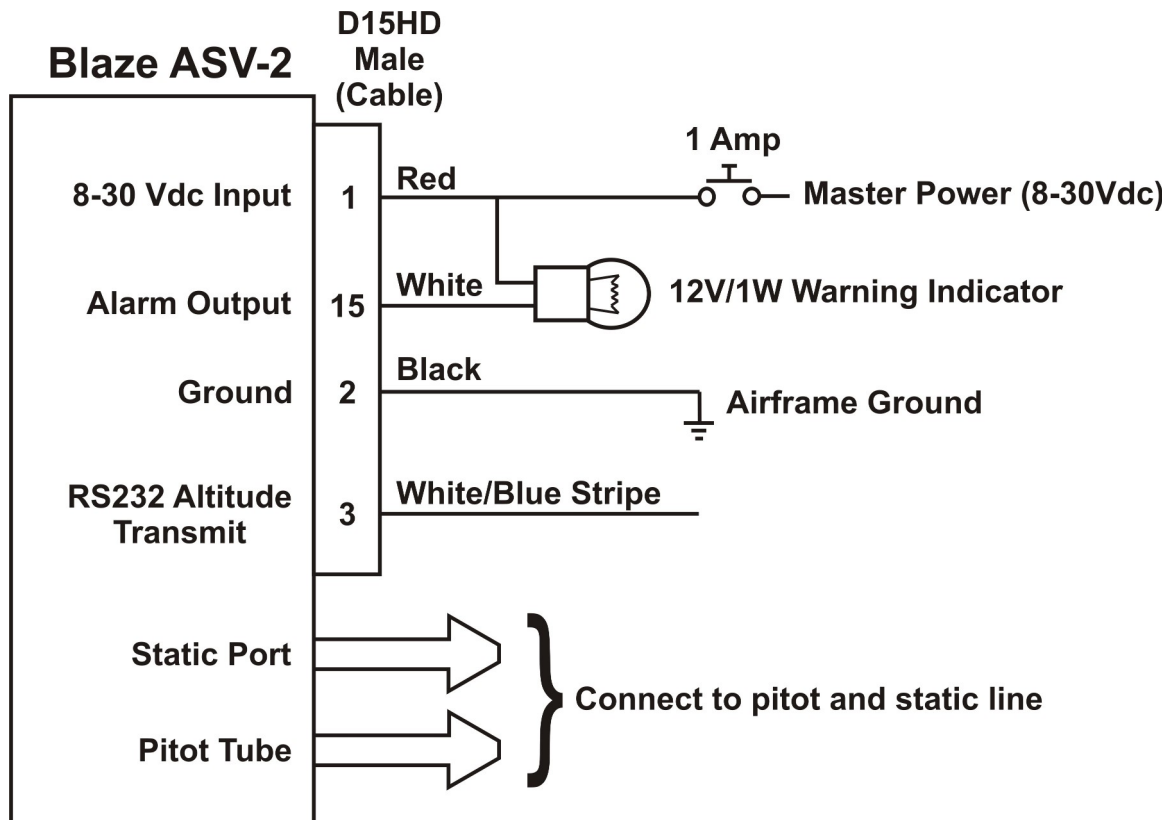

10.2 Pressure Port Dimensions

Version 1 pressure ports (Plastic)

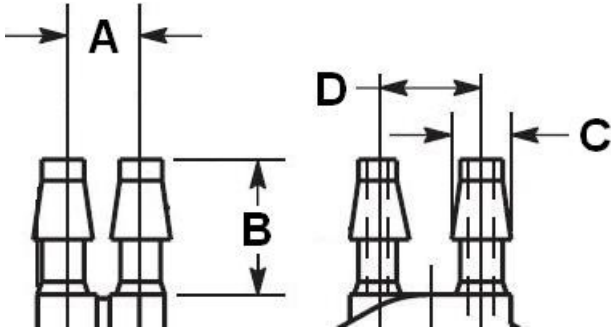

	Inches		Millimeters	
	Min	Max	Min	Max
A	0.248	0.278	6.30	7.06
B	0.420	0.440	10.67	11.18
C	0.182	0.194	4.62	4.93
D	0.310	0.330	7.87	8.38

Version 2 pressure ports (Brass)

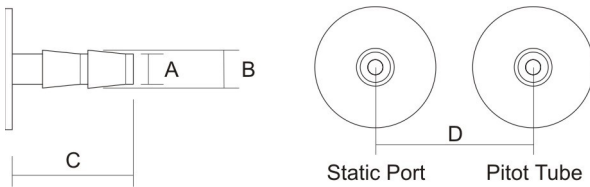

	Inches	Millimeters
A	0.157	4
B	0.197	5
C	0.63	16
D	0.79	20

10.3 Cable connections

Main connector (D15 connector: Unit Female, Cable Male)

D15 Pin	Color	Function
1	Red	8-30Vdc power via power switch / circuit breaker and fuse.
2	Black	Ground.
3	White/Blue Stripe	RS232 Transmit data (Firmware upgrading / RS232 Altitude output)
4	-	RS232 Receive data (Firmware upgrading)
15	White	Alarm Output (Open collector)

10.4 CNV-ALT (Serial altitude to parallel Gillham code converter)



The CNV-ALT accepts RS232 serial data from a compatible MGL Avionics instrument and produces parallel Gillham codes in a format compatible with mode C transponders. The ASV-2 serial protocol must be set to MGL Avionics.

11 Dimensions

Stratomaster Blaze 3.125" (80mm) Dimensions

FRONT VIEW

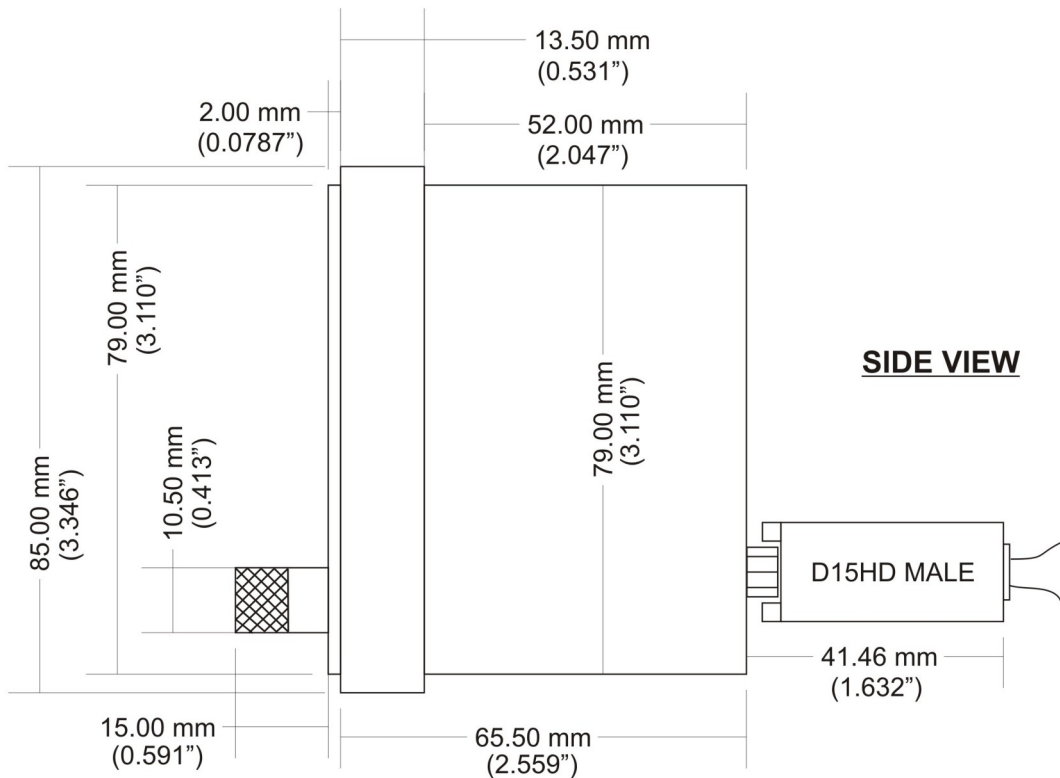
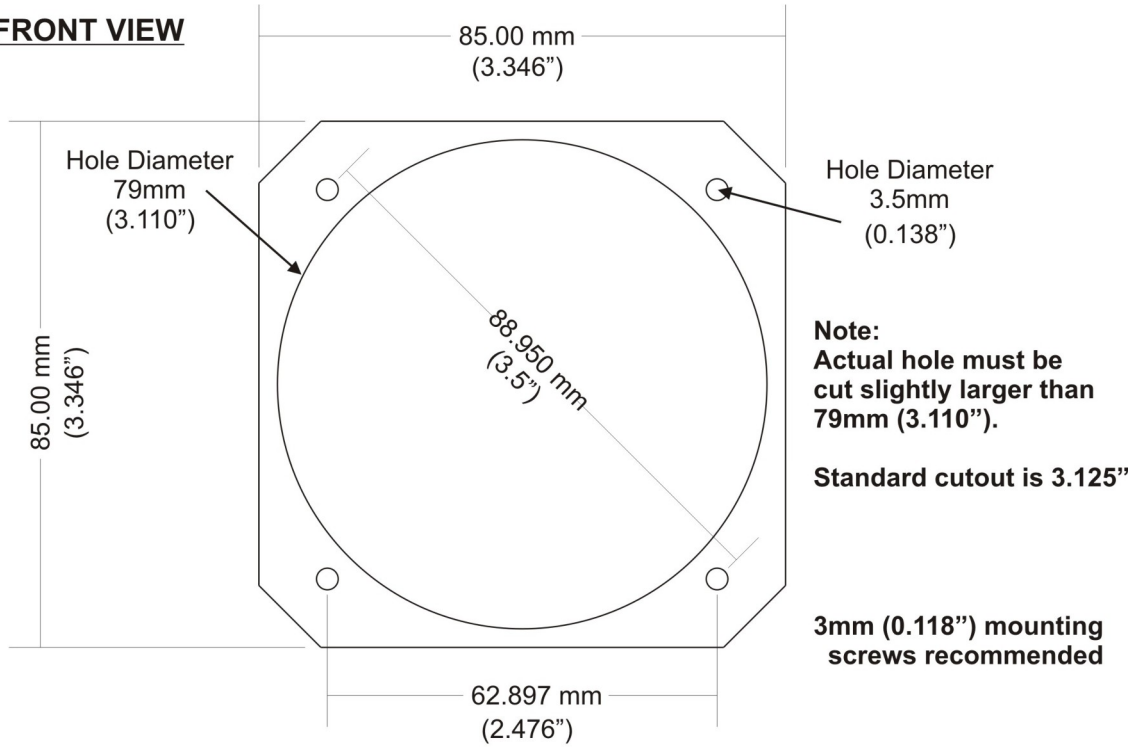

12 Cleaning

The unit should not be cleaned with any abrasive substances. The screen is very sensitive to certain cleaning materials and should only be cleaned using a clean, damp cloth.

Warning: The ASV-2 is not waterproof, serious damage could occur if the unit is exposed to water and/or spray jets.

13 Warranty

This product carries a warranty for a period of one year from date of purchase against faulty workmanship or defective materials, provided there is no evidence that the unit has been mishandled or misused. Warranty is limited to the replacement of faulty components and includes the cost of labor. Shipping costs are for the account of the purchaser.

Note: Product warranty excludes damages caused by unprotected, unsuitable or incorrectly wired electrical supplies and or sensors, and damage caused by inductive loads.

14 Disclaimer

Operation of this instrument is the sole responsibility of the purchaser of the unit. The user must make themselves familiar with the operation of this instrument and the effect of any possible failure or malfunction.

This instrument is not certified by the FAA. Fitting of this instrument to certified aircraft is subject to the rules and conditions pertaining to such in your country. Please check with your local aviation authorities if in doubt. This instrument is intended for ultralight, microlight, home built and experimental aircraft. Operation of this instrument is the sole responsibility of the pilot in command (PIC) of the aircraft. This person must be proficient and carry a valid and relevant pilot's license. This person has to make themselves familiar with the operation of this instrument and the effect of any possible failure or malfunction. Under no circumstances does the manufacturer condone usage of this instrument for IFR flights.

IMPORTANT NOTICE:

You must make your own determination if the products sold by MGL Avionics are safe and effective for your intended applications. MGL Avionics makes no representations or warranties as to either the suitability of any of the products we sell as to your particular application or the compatibility of any of the products we sell with other products you may buy from us or anywhere else, and we disclaim any warranties or representations that may otherwise arise by law. Also, we offer no specific advice on how to install any of the products we sell other than passing along anything that may have been provided to us by the manufacturer or other issues. If you are in need of further information or guidance, please turn to the manufacturer, FAA Advisory Circulars and guidance materials, the Experimental Aircraft Association, or other reputable sources.

Continuing development sometimes necessitates specification changes without notice.

Other instruments in the *Stratomaster Blaze* series

AHRS-2	Artificial Horizon and Magnetic Compass Indicator
AHRS-4	Self contained Artificial Horizon and Magnetic Compass Indicator
ALT-6	Altimeter and Vertical Speed Indicator (VSI)
ALT-7	Altimeter and Vertical Speed Indicator (VSI) with a transponder compatible RS232 & parallel Gillham code output
ASI-5	Airspeed Indicator (ASI)
ASV-2	Altimeter, Airspeed (ASI) and Vertical Speed Indicator (VSI)
EMS-2	Engine Monitoring System
FF-5	Fuel Computer
FLIGHT-3	Primary Flight Instrument
INFO-2	Information Display (G-Force meter, UTC and Local Time, Slip Indicator, Outside Air Temperature (OAT), Battery Voltage, Current and charge display, Flight Timer & Flight Log, Stopwatch, Countdown Timer and Alarm)
MAG-2	Magnetic Compass Indicator
MAP-4	Manifold Pressure and RPM Indicator
RPM-2	Universal Engine / Rotor RPM Indicator
TC-5	4 Channel Thermocouple (EGT/CHT) Indicator
TC-6	12 Channel Thermocouple (EGT/CHT) Indicator
TP-4	4 Channel Universal Analog Input (Pressure/Temperature/Current/Volts) Indicator