

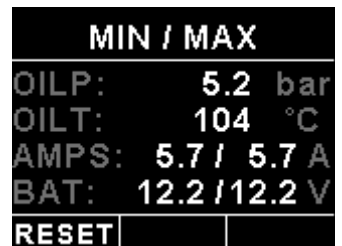

Blaze TP-4

4 Channel Universal Analog input
(Pressure / Temperature / Current / Volts /
Fuel Level / Generic Analog input)
indicator

Operating Manual – English 1.07

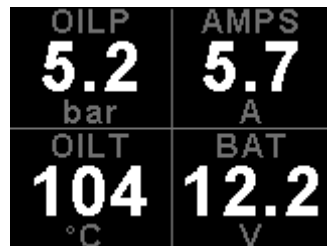
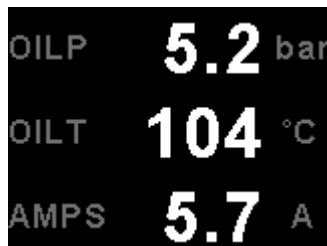
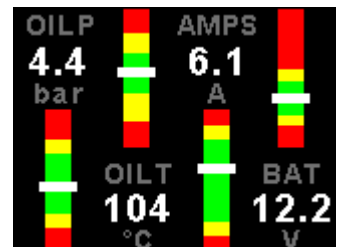
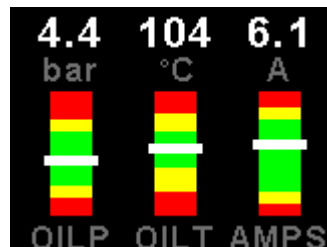
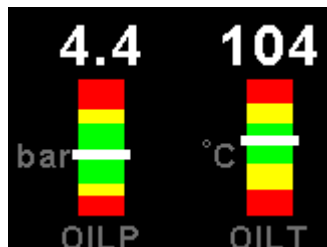
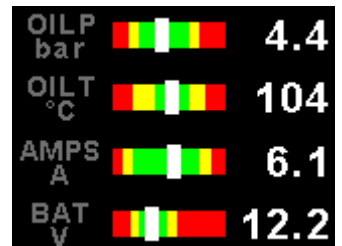
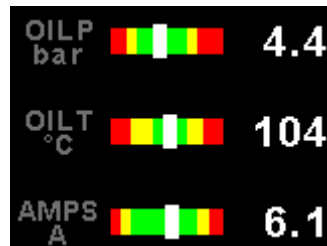
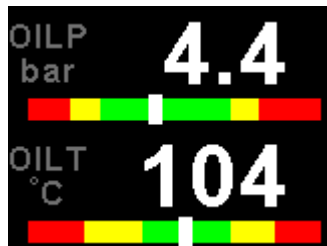

Introduction

The TP-4 is a 3 1/8" (80mm) sunlight readable 4 channel universal analog input color display instrument. Each channel can be individually programmed to display either pressure, temperature, current, volts, fuel level or as a generic input from a universal analog input that can interface to many sensors such as oil temperature, coolant temperature, oil pressure, fuel pressure, manifold pressure, boost pressure and many more.

The TP-4 can display any combination of 1 to 4 analog channels in a horizontal / vertical bargraph or a numeric display format.

Pressure can be measured using standard automotive resistive senders (e.g. VDO 2, 5 and 10 Bar), Rotax 4-20mA senders as well as voltage output pressure senders (e.g. UMA). Temperature can be measured using standard automotive resistive senders (e.g. VDO, Westach) as well as the MGL Avionics precision LM335 semiconductor sensor. In addition the temperature, pressure and current inputs can be programmed to a user defined curve for custom senders.

All analog channels have a programmable low and high alarm. This results in a contact closure that is typically used to switch a warning lamp on. The TP-4 also records the minimum and maximum values reached for each channel in permanent memory.

The TP-4 can also be interfaced via the CAN bus to an external RDAC unit (Remote Data Acquisition Computer). This allows for easier installation as the RDAC unit is normally mounted in the engine compartment.

1 Features

- Large 2.6" high resolution 320x240, IPS (fully viewable in all directions), sunlight readable color LCD display
- Four universal analog inputs that can be used for pressure / temperature / current / volts / fuel level or as a generic analog input
- Pressure can be measured using standard automotive resistive senders (e.g. VDO 2, 5 and 10Bar), Rotax 4-20mA senders as well as voltage output pressure senders (e.g. UMA)
- Temperature can be measured using standard automotive resistive senders (e.g. VDO, Westach) as well as the MGL Avionics precision LM335 semiconductor sensor
- Current can be measured using the Closed Loop Current Sensor (Sold Separately)
- High accuracy: Built in linearization curves for common senders
- Analog channels can be programmed to a user defined curve for custom senders
- Supports the Rotax 4-20mA pressure sender as used in the 912/914 engines
- Temperatures can be displayed in °C or °F
- Pressure can be displayed in psi or bar
- Records minimum and maximum values reached for each channel
- External RDAC (Remote Data Acquisition Computer) interfacing via the CAN bus
- Includes a RS232 serial output for interfacing to external equipment e.g dataloggers etc.
- Standard 3 1/8" (80mm) aircraft enclosure (can be front or rear mounted)
- The LED backlight can automatically adjust to the ambient light, or it can be manually adjusted in the menu system
- Rotary control plus 2 independent buttons for easy menu navigation and user input
- An external output activates when a high alarm condition has been reached
- Wide input supply voltage range of 8 to 30V DC with built in voltage reversal and over voltage protection for harsh electrical environments
- 1 year limited warranty

2 Layout

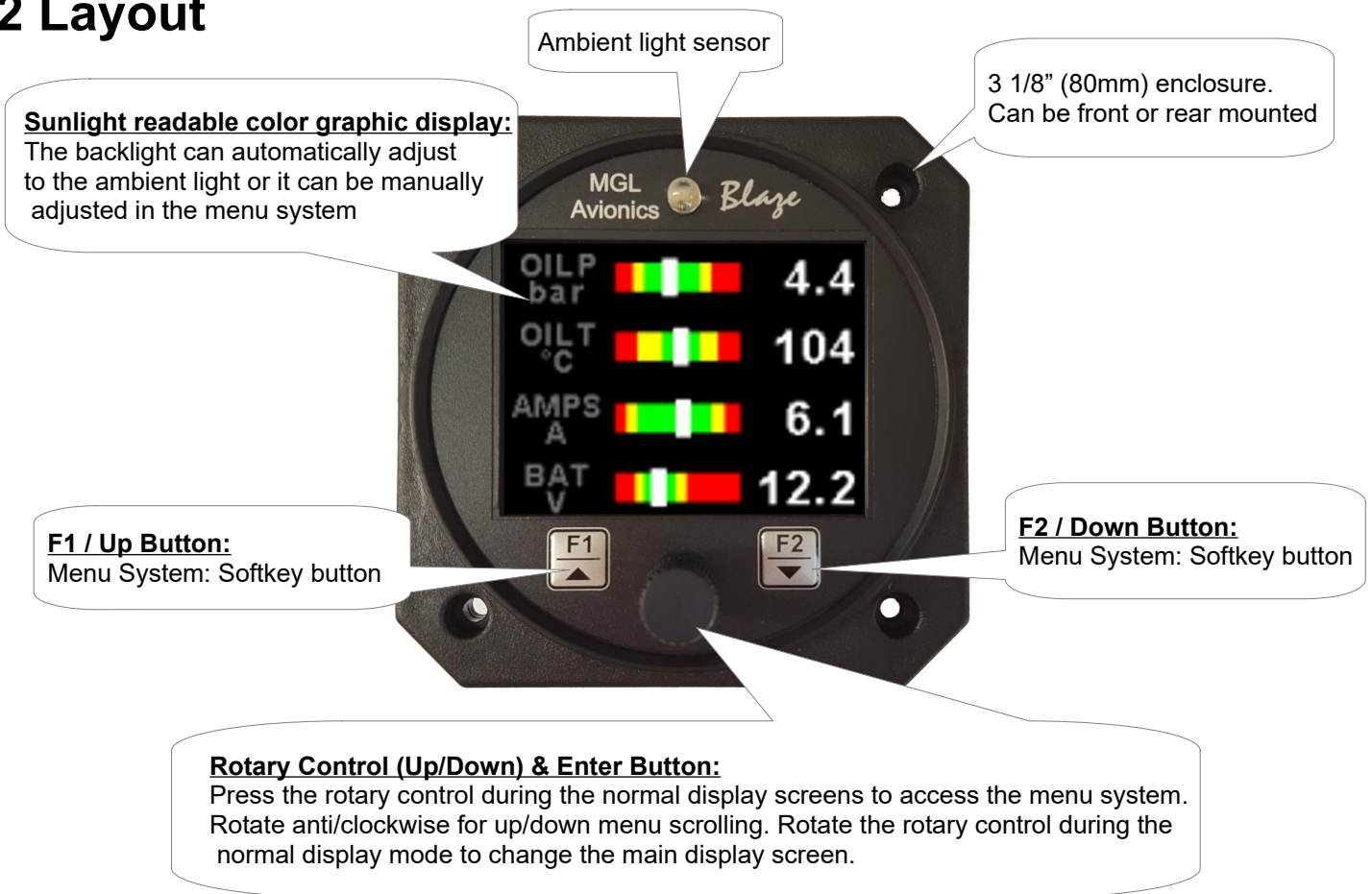

3 Main Displays

The TP-4 has 3 different main display screens. The main display screen can be selected by rotating the rotary control.

Horizontal Display

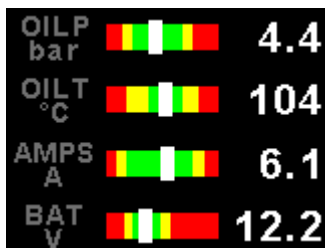

Vertical Display

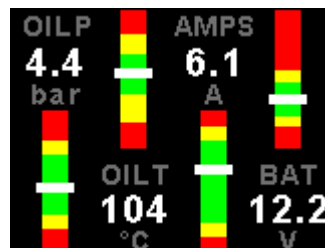

Numeric Display

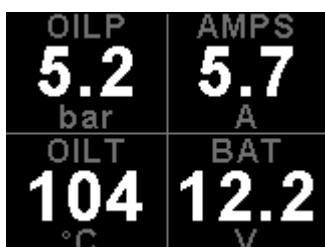

Max Values

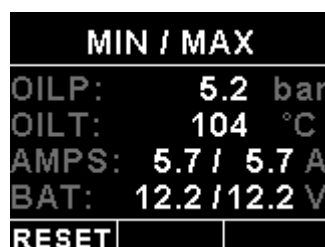

3.1 Horizontal display

The below images show the horizontal display mode displaying 1,2,3 and 4 channels



3.2 Vertical display

The below images show the vertical display mode displaying 1,2,3 and 4 channels



3.3 Numeric display

The below images show the numeric display mode displaying 2,3 and 4 channels

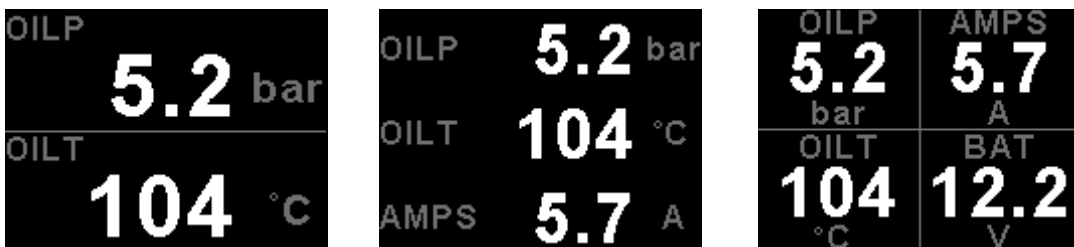

3.4 Maximum Values display

MIN / MAX	
OILP:	5.2 bar
OILT:	104 °C
AMPS:	5.7 / 5.7 A
BAT:	12.2 / 12.2 V
RESET	

This display can be accessed by rotating the rotary control during the normal display mode. Press the F1/Up button when the max values display is showing to reset the maximum values.

Note: The maximum values are stored in non-volatile memory and are recalled on power-up.

4 Menu System

Press the rotary control button during the normal display mode to enter the menu system. Use the rotary control to navigate through the menu system.

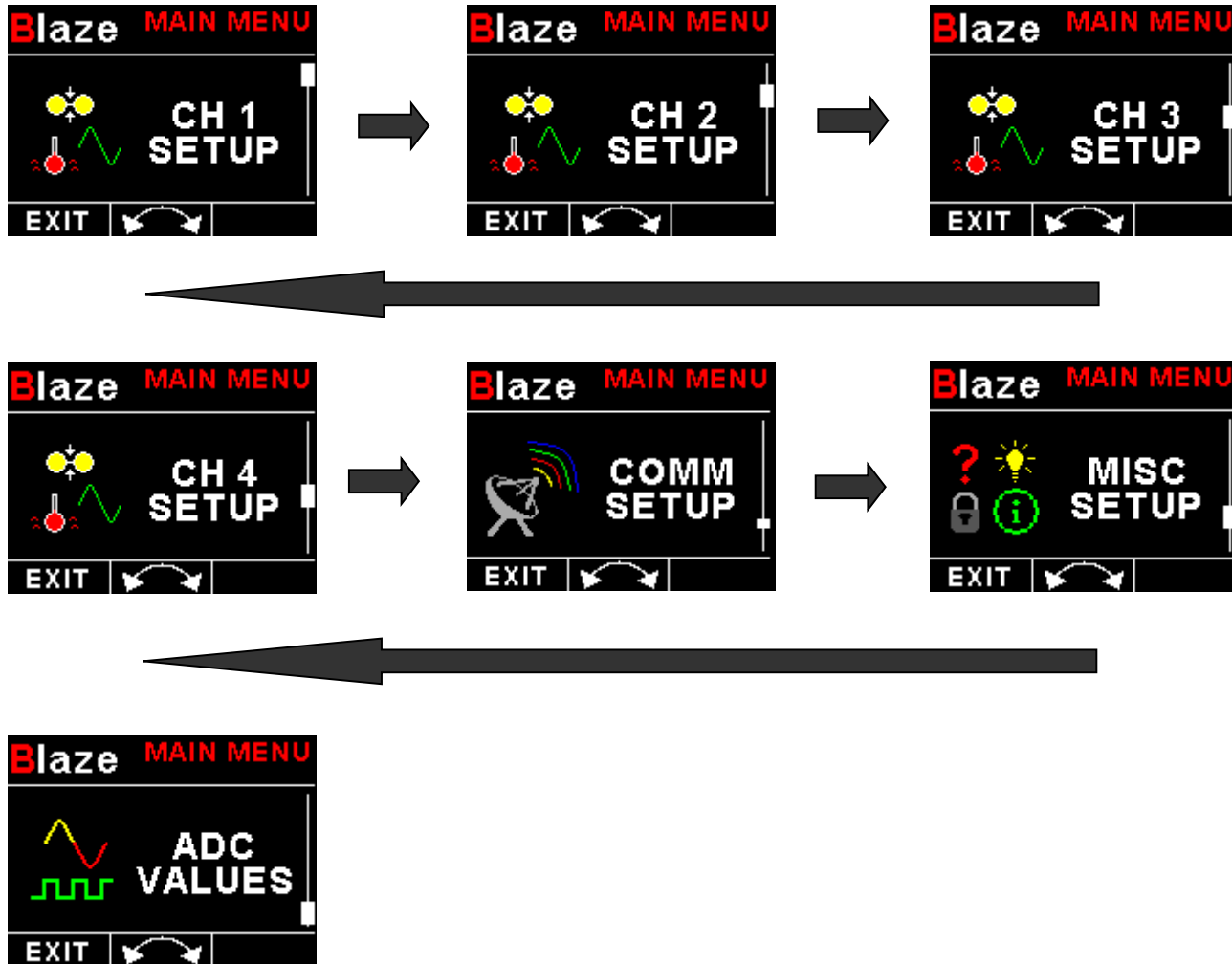

4.1 Exiting the menu system

Press the F1/Up button to exit the menu system when the "EXIT" soft key is shown. All changes made during navigation of the menu system will be saved in non-volatile memory upon exiting. The instrument will not save any changes if you remove power before exiting the menu system.

4.2 CH1 to CH4 Setup (Analog Channel Setup)

The 4 analog channels are universal analog input channels that can be used for pressure, temperature, current, volts, fuel level or as a generic analog input.

Only “CHANNEL 1” Setup is shown below, follow the same steps for Channel 2, 3 & 4

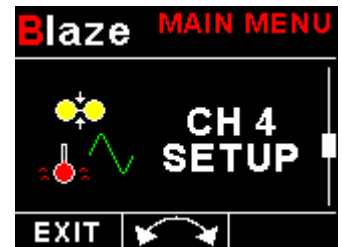
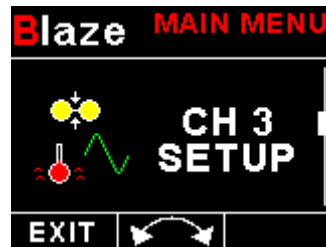
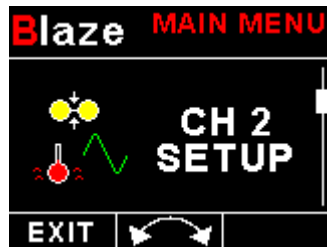
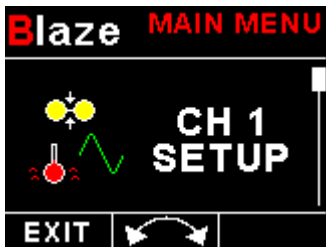

4.2.1 Pressure Setup

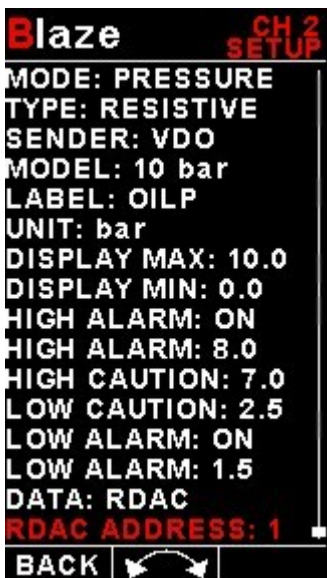

Mode:

Select the function for the analog channel. Options are “PRESSURE”, “TEMP”, “CURRENT”, “VOLTS”, “FUEL LEVEL”, “GENERIC” or “OFF”.

Type:

Select if you are using a resistive, voltage or current pressure sender.

If the “RESISTIVE” pressure sender is selected

Sender:

Select what type of resistive pressure sender you are using. Select “VDO” for VDO / resistive senders, “USER” for a custom sender.

Model:

Select which VDO pressure sender you are using. A selection between a VDO 2, 5 or 10 Bar can be selected.

If the “VOLTAGE” pressure sender is selected**Sender:**

Select the type of voltage sender you are using. Select “UMA” for UMA senders, “0.5-4.5V” for voltage senders, or “USER” for a custom voltage sender.

Model:

For UMA senders select the UMA model number.

If the “CURRENT” pressure sender is selected**Sender:**

Select the type of current sender you are using. Select “4-20mA” for Rotax 912/914 4-20mA sender or “USER” for a custom 4-20mA sender.

Pressure @ 4mA:

Enter the pressure specified at 4mA output.

Pressure @ 20mA:

Enter the pressure specified at 20mA output.

Menu options for all sender types**If the “USER” pressure sender is selected****Calibrate Sender:**

If the sender type is set to “USER”, then use this menu option to calibrate your pressure sender. See section 4.2.3 for more information.

Label:

Enter a label to suit your pressure channel so you can identify it easily.

Unit:

Select whether you want to display the pressure in Bar, psi or psi(0.1). The psi(0.1) is for low range pressure senders e.g. UMA 7PSI.

Display Max:

Select the maximum pressure that you want the bargraph to show. This can give you increased display resolution.

Display Max:

Select the minimum pressure that you want the bargraph to show. This can give you increased display resolution.

High Alarm:

This enables or disables the pressure high alarm.

High Alarm:

Enter the pressure threshold for when the high alarm must be activated. Any pressure above this value will activate the alarm.

High Caution:

Enter the pressure value for the high caution. This is the lower value of the upper yellow band.

Low Caution:

Enter the pressure value for the low caution. This is the upper value of the lower yellow band.

Low Alarm:

This enables or disables the pressure low alarm.

Low Alarm:

Enter the pressure threshold for when the low alarm must be activated. Any pressure below this value will activate the alarm.

Data:

Select the data source of the pressure signal. Options include internal (using one of the analog channels within the TP-4) or from an optional external RDAC unit.

RDAC Address:

Select the CAN address of the RDAC unit.

4.2.2 Temperature Setup



Mode:

Select the function for the analog channel. Options are “PRESSURE”, “TEMP”, “CURRENT”, “VOLTS”, “FUEL LEVEL”, “GENERIC” or “OFF”.

Sender:

Select what type of sender you are using. Select “VDO 120” for a VDO 120 degree NTC sender, Select “VDO 150” for a VDO 150 degree NTC sender, “WESTACH” for Westach 339 NTC sender, “MGL” for a MGL NTC sender, “LM335” for a MGL precision temperature sender or “USER” for a custom sender.

If the sender type is set to “USER”

CALIBRATE SENDER:

If the sender type is set to “USER”, then use this menu option to calibrate your pressure sender. See section 4.2.3 for more information.

If the sender type is set to “LM335”

LM335:

If the sender type is set to LM335, then use this menu option to calibrate your LM335 precision temperature sender. If recalibration is required then adjust the value until the temperature matches the reference ambient temperature. Please note that the LM335 can only be calibrated in degrees Celsius irrespective if the TP-4 is setup to display temperature in Fahrenheit.

Menu options for all sender types

Label:

Enter a label to suit your temperature channel so you can identify it easily.

Temp Unit:

Select whether you want the temperature to be displayed in degrees Celcius (°C) or in degrees Fahrenheit (°F).

Display Max:

Select the maximum temperature that you want the bargraph to show. This can give you increased display resolution.

Display Min:

Select the minimum temperature that you want the bargraph to show. This can give you increased display resolution.

High Alarm:

This enables or disables the temperature high alarm.

High Alarm:

Enter the temperature threshold for when the high alarm must be activated. Any temperature above this value will activate the alarm.

High Caution:

Enter the temperature value for the high caution. This is the lower value of the upper yellow band.

Low Caution:

Enter the temperature value for the low caution. This is the upper value of the lower yellow band.

Low Alarm:

This enables or disables the temperature low alarm.

Low Alarm:

Enter the temperature threshold for when the low alarm must be activated. Any temperature below this value will activate the alarm.

Data:

Select the data source of the temperature signal. Options include internal (using one of the analog channels within the TP-4) or from an optional external RDAC unit.

RDAC Address:

Select the CAN address of the RDAC unit.

4.2.3 Calibrating the user defined pressure, temperature or generic input analog senders

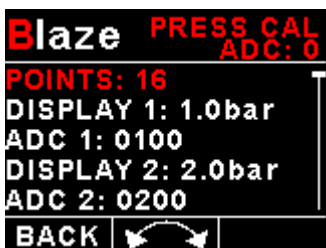

1. Enter the number of points that you want to calibrate.
2. Enter the display reading that you want to show when the sender is at that actual display reading.
3. Enter the ADC (analog to digital converter) reading that corresponds to this display reading. The ADC reading is shown at the top of the display if you are applying the actual stimulus from the temperature, pressure or current sender. You can also manually enter this value if the ADC value is known or pre-calculated.
4. Continue entering display and ADC values until all the points have been entered.
5. Verify the above calibration by checking the temperature, pressure or current display versus the actual applied sender stimulus.

4.2.4 Current Setup (MGL Avionics Magnetic Closed Loop Current Sensor required)

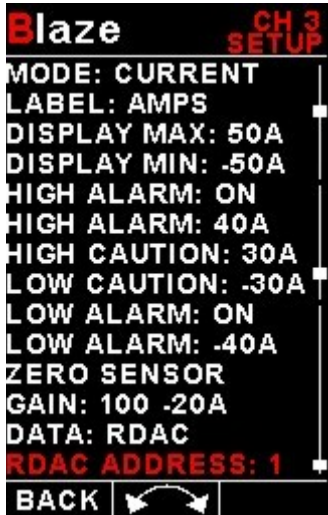

Mode:

Select the function for the analog channel. Options are "PRESSURE", "TEMP", "CURRENT", "VOLTS", "FUEL LEVEL", "GENERIC" or "OFF".

Label:

Enter a label to suit your current channel so you can identify it easily.

Display Max:

Select the maximum current that you want the bargraph to show. This can give you increased display resolution.

Display Min:

Select the minimum current that you want the bargraph to show. This can give you increased display resolution.

High Alarm:

This enables or disables the current high alarm.

High Alarm:

Enter the current threshold for when the high alarm must be activated. Any current above this value will activate the alarm.

High Caution:

Enter the current value for the high caution. This is the lower value of the upper yellow band.

Low Caution:

Enter the current value for the low caution. This is the upper value of the lower yellow band.

Low Alarm:

This enables or disables the current low alarm.

Low Alarm:

Enter the current threshold for when the low alarm must be activated. Any current below this value will activate the alarm.

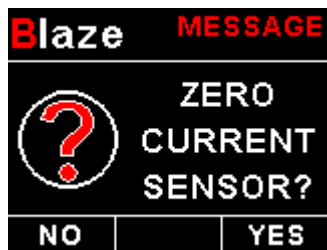
Zero Sensor:

Select this function to indicate to the TP-4 that zero current is flowing through the MGL Avionics Closed Loop Current sensor. This is best done with the MGL Closed Loop Current sensor disconnected from the main current supplying conductor.

Gain:

Adjust the gain factor until the current is reading correctly. It will be best if a multimeter can be inserted in series with the current supplying conductor and the gain calibration adjusted until the TP-4 matches that of the multimeter. Please see the MGL Avionics Closed Loop Current Sensor documentation for more information.

Data:

Select the data source of the current signal. Options include internal (using one of the analog channels within the TP-4) or from an optional external RDAC unit.

RDAC Address:

Select the CAN address of the RDAC unit.

4.2.5 Volts Setup

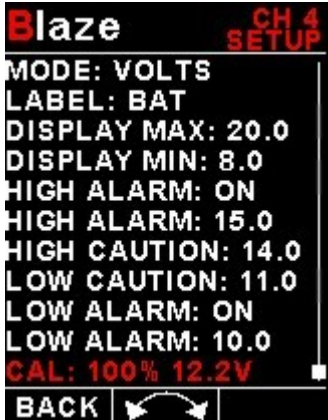

Mode:

Select the function for the analog channel. Options are “PRESSURE”, “TEMP”, “CURRENT”, “VOLTS”, “FUEL LEVEL”, “GENERIC” or “OFF”.

Label:

Enter a label to suit your volts channel so you can identify it easily.

Display Max:

Select the maximum value that you want the volts bargraph to show. This can give you increased display resolution.

Display Min:

Select the minimum value that you want the volts bargraph to show. This can give you increased display resolution.

High Alarm:

This enables or disables the volts high alarm.

High Alarm:

Enter the voltage threshold for when the high alarm must be activated. Any voltage above this value will activate the alarm.

High Caution:

Enter the voltage for the high caution. This is the lower value of the upper yellow band.

Low Caution:

Enter the voltage for the low caution. This is the upper value of the lower yellow band.

Low Alarm:

This enables or disables the volts low alarm.

Low Alarm:

Enter the voltage threshold for when the low alarm must be activated. Any voltage below this value will activate the alarm.

Cal:

Measure the battery voltage with a multimeter and then adjust this value to match that of the multimeters volts reading.

4.2.6 Fuel Level Setup

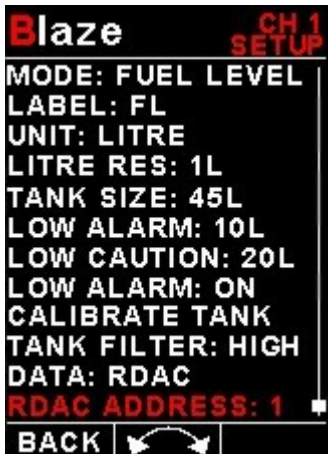

Mode:

Select the function for the analog channel. Options are "PRESSURE", "TEMP", "CURRENT", "VOLTS", "FUEL LEVEL", "GENERIC" or "OFF".

Label:

Enter a label to suit your fuel level channel so you can identify it easily.

Unit:

Select whether you want the fuel level to be displayed in Litres or in Gallons.

Litre Res:

Select the resolution of the Litre unit. 1L or 0.1L

Tank Size:

Enter the size of the fuel tank in your system. It is recommended to choose a size that is slightly less than actual size so you can compensate for sender inaccuracies and give you a measure of reserve fuel.

Low Alarm:

Enter your desired minimum fuel value that you would like to trigger the fuel low alarm. The fuel low alarm will result in the flashing of the fuel level display and remaining fuel readout. You can also connect a warning lamp to the external alarm output (see installation diagram). Note that the fuel low level will be displayed as a red bar on your fuel level display. This level is over and above your "silent" fuel reserve.

Low Caution:

Enter the fuel level value for your fuel caution. Note that the fuel caution level will be displayed as a yellow bar on your fuel level display.

Low Alarm:

Select whether to turn the fuel tank 1 low level alarm on or off.

Calibrate Tank:

See section 4.2.6.1 on how to calibrate the fuel level senders.

Tank Filter:

Select the damping factor for the fuel level. A selection of none, low, med or high can be made.

Data:

Select the data source of the current signal. Options include internal (using one of the analog channels within the TP-4) or from an optional external RDAC unit.

RDAC Address:

Select the CAN address of the RDAC unit.

4.2.6.1 Calibrating the fuel level senders

The fuel level sender needs to be calibrated before it can be used with this system. The calibration allows the system to learn the shape of your tank as well as any errors your fuel level sender or installation has.

Regardless of your use of a fuel flow sender, you can install a fuel level sender into your fuel tank. These level senders are inexpensive and are available as after market replacement fittings from a car spares outlet. We recommend the senders available from VDO.

Be aware that some makes of cheap level senders can prove troublesome, as the lever arms tend to be sticky. This prevents the floats from floating on the surface of the fuel at all times. As a consequence, this will lead to incorrect fuel level indication.

Adjusting calibration points automatically

Select "SENDER" for the mode menu item. Once you have installed a fuel level sender into your tank, make sure the float can travel all the way from empty to full position without hindrance of any kind. The calibration procedure should be carried out with your aircraft in flight attitude. This means you need to lift the tail if you have a tail-dragger or lift the nose wheel if you have a weight shift trike.

Calibration procedure

- Start the calibration procedure with an empty tank.
- Add five Litres of fuel (our reserve quantity) using a suitable measure. Make sure the measure is suitably accurate. This is now the "level sender reading at 0 Lt" position. Move the highlight to this position and wait until the sender reading has stabilized (You will see the sender ADC reading at the top). This could take up to a minute so have patience.

ENSURE THAT THE FLOAT IS NOT SUBMERGED AND IS FLOATING ON TOP OF THE FUEL LEVEL.

Should this number not react to changes of your level sender position, then you have a problem. Please check your wiring according to the installation section of this manual. You should expect the number to change in the region of at least 20 to 60 counts per calibration position. If the number does not change with fuel level or only changes a very small amount – check your installation. Something is not right!

- If you see the number changing then everything is well. Once it has stabilized and the highlight is on the 0 L position, press the rotary control to transfer the reading from the sender to the calibration point.
- Now you are ready for the next step. Add the required amount of fuel to get to the next level (In our case 9 Lt – this is 20% tank capacity). Once done, wait for the reading to stabilize and press the rotary control again after you have moved the highlight to the "9 L" position.
- Proceed in a similar manner until you have reached the last calibration position at 100% tank capacity.

You are done!

To finish your calibration, exit the calibration function.

The instrument uses the 6 calibration points to work out a correction curve that takes into account the tolerances of your fuel level sender and the shape of your fuel tank. This results in an incredibly accurate and usable fuel level display that far exceeds that available from ordinary dial type gauges.

Adjusting calibration points manually

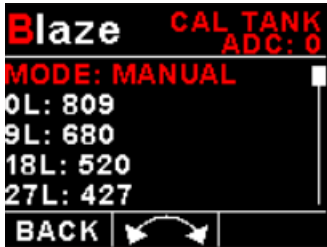

You may want to set individual calibration points manually. For example you may find that your fuel level is over reading at a specific fuel level. Correcting the tank level reading for this area can be simply done by adjusting the calibration point. You can do this by moving the float level with your hands to the desired position and then performing the calibration as outlined above, or you can use the manual option.

Select "MANUAL" for the mode menu item. Then highlight the point you want to change manually and press the rotary control. Use the up or down keys or the rotary control to adjust the value. Press the rotary control when done.

Note: The calibration positions may be edited by using the rotary control. This allows you, in theory, to copy calibration settings from one instrument to another. We however recommend that you do go through the calibration procedure even if the two aircraft are identical in all respects. Tolerances do exist and the calibration cancels these out. Accurate fuel level displays are a vital safety factor for an aircraft and a very useful feature for peace of mind during cross county flights.

Notes on Slope error



Sender value is a value determined by the TP-4. It is used to calculate fuel level, fuel endurance estimate and current range estimate. The fuel tank setup sender value can either increase in value as fuel is added or decrease in value if fuel is added. This is dependent on the type of fuel level sender used. However should the second reading be larger than the first reading all readings will have to be larger than the previous readings. Likewise should the second reading be smaller than the first reading all readings will have to be smaller than the previous reading.

If this is not the case the wording "Slope error" will be displayed. This could happen when fuel was removed instead of added between steps, no fuel was added between steps or when the fuel level sender was moved in the wrong direction e.g. moving the fuel level sender manually when it is not inserted in to the fuel tank. Determine the cause of the error if you should get a slope error message. If you do not know the cause of your error it is best to start from scratch. It should be remembered that accuracy in the fuel tank calibration is extremely important to enable your TP-4 to display the correct data.

4.2.7 Generic Analog Input Setup



Mode:

Select the function for the analog channel. Options are "PRESSURE", "TEMP", "CURRENT", "VOLTS", "FUEL LEVEL", "GENERIC" or "OFF".

Calibrate Sender:

Use this menu option to calibrate your generic analog input sender. See section 4.2.3 for more information. Use 2 points if the sensor is linear.

Label:

Enter a label to suit your generic analog input channel so you can identify it easily.

Unit Label:

Enter a unit label to suit your generic analog input channel.

Decimal Point:

Enter the decimal point position.

Display Max:

Select the maximum input that you want the bargraph to show. This can give you increased display resolution.

Display Min:

Select the minimum input that you want the bargraph to show. This can give you increased display resolution.

High Alarm:

This enables or disables the high alarm.

High Alarm:

Enter the threshold for when the high alarm must be activated. Any input above this value will activate the alarm.

High Caution:

Enter the input value for the high caution. This is the lower value of the upper yellow band.

Low Caution:

Enter the input value for the low caution. This is the upper value of the lower yellow band.

Low Alarm:

This enables or disables the low alarm.

Low Alarm:

Enter the threshold for when the low alarm must be activated. Any input below this value will activate the alarm.

Data:

Select the data source of the input signal. Options include internal (using one of the analog channels within the TP-4) or from an optional external RDAC unit.

RDAC Address:

Select the CAN address of the RDAC unit.

4.3 COMM Setup (Communication Setup)



Serial Out:

Select "ON" to enable the RS232 serial output.

Unit Address:

Enter the unit address.

Baud Rate:

Select the desired baud rate of the serial output.

The transmission format is set to 8 data bits, No parity, 1 stop bit. The baud rate can be changed in the Communication Menu.

4.3.1 Protocol Format

STX, Address, Message type, Length, Data payload, Checksum, ETX

STX: Start of text (0x02)

Address: unsigned char (8bit), Unit address (range 0-255)

Message Type: unsigned char (8bit), Specifies the message type

Length: unsigned char (8bit), Length of the data payload (does not include the STX, Address, message type, checksum or ETX)

Data payload: Data

Checksum: unsigned char (8bit), XOR of all bytes starting from the unit address to the end of the data payload. The checksum is seeded with 0xa5. (does not include the STX or ETX)

ETX: End of text (0x03)

4.3.2 Data payload

Message type=8

Data Length=10 bytes

Output Rate=1Hz

Analog Channel Type: Unsigned Int (16 bits)

CH4 (4 bits), CH3 (4 bits), CH2 (4 bits), CH1 (4 bits)

0=Off

1=Pressure

2=Temperature

3=Current

4=Volts

5=Fuel Level

6=Generic

Analog Channel 1: Signed Int (16 bits)

Pressure in 0.1psi

Temperature in Degrees C

Current in 0.1A

Volts in 0.1V

Fuel Level in Liters

Generic in user units

Analog Channel 2: Signed Int (16 bits)

Pressure in 0.1psi

Temperature in Degrees C

Current in 0.1A

Volts in 0.1V

Fuel Level in Liters

Generic in user units

Analog Channel 3: Signed Int (16 bits)

Pressure in 0.1psi

Temperature in Degrees C

Current in 0.1A

Volts in 0.1V

Fuel Level in Liters

Generic in user units

Analog Channel 4: Signed Int (16 bits)

Pressure in 0.1psi

Temperature in Degrees C

Current in 0.1A

Volts in 0.1V

Fuel Level in Liters

Generic in user units

4.4 MISC Setup (Miscellaneous Setup)



Backlight:



Select manual or automatic backlight control.

Use the rotary control in manual mode to adjust the backlight brightness.



Allow 3 seconds for the display to adjust to the ambient lighting conditions when using the automatic backlight mode. The display will set the backlight to the dim setting if the ambient light is less than the threshold setting, alternatively the display will set the backlight to the bright setting if the ambient light is greater than the threshold setting. The ambient light received is shown as the ADC value in the top header. Use this value to set the threshold value.

Security Setup:



Select this menu option if you want to password protect the menu system.

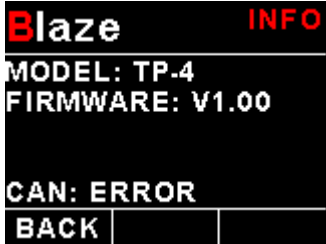

Information:

This menu option displays information about the unit.

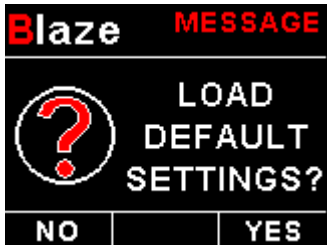
Default Settings:

Select this menu option to reset all the settings to factory defaults.

5 Loading factory default settings



Press and hold the F1/Up button and rotary control during power up to load the pre-programmed factory default settings. The following screen will be displayed:

Factory default settings can also be loaded in the Miscellaneous setup menu.

6 Error Messages



UNIT
SETTINGS
CRC ERROR

Unit settings CRC error. Load default settings to restore to factory defaults. If the error message still persists then it could possibly be a non-volatile memory failure in which case the instrument will then have to be returned to the factory.



INTERNAL
FLASH
CRC ERROR
UNIT:123456
CODE:654321

Internal flash CRC error. The instrument does a firmware check on the program when power is applied to the instrument . If the program is corrupt in any way then the internal flash CRC error will be displayed. Reload the instruments firmware and load default settings. If the error message still persists then it could possibly be an internal flash memory failure in which case the instrument will then have to be returned to the factory.



MAX VALUES
CRC ERROR

Max Values CRC error. Load default settings to restore to factory defaults. If the error message still persists then it could possibly be a non-volatile memory failure in which case the instrument will then have to be returned to the factory.

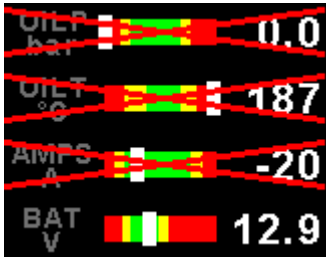

The red cross over the display means the TP-4 has lost communications with the external RDAC unit. Check the wiring between the TP-4 instrument and the RDAC unit. This error message is only available when the external RDAC is selected as the analog data source.

7 Specifications

Operating Temperature Range	-10°C to 60°C (14°F to 140°F)
Storage Temperature Range	-20°C to 80°C (-4°F to 176°F)
Humidity	<85% non-condensing
Power Supply	8 to 30Vdc SMPS (switch mode power supply) with built in 33V over voltage and reverse voltage protection
Current Consumption	Approx. 125mA @ 12V (backlight highest setting), 50mA @12V (backlight lowest setting)
Display	2.6" 320x240 IPS color LCD display Minimum 600cd/m2 brightness Sunlight readable with anti-glare coating LED Backlight can be set to automatic or can be manually adjusted
Alarm Output	Open collector transistor switch to ground Maximum rating 0.25A
ADC	12 bit
Dimensions	see Blaze series dimensional drawing
Enclosure	3 1/8" (80mm) ABS, black in color, front or rear mounting. Flame retardant.
Weight	Approx. 160 grams (Instrument excluding cables)
Non-volatile memory storage	100000 write cycles
Analog Input Channels	4 total with dipswitch programmable pullup resistor
Pressure Sensors	<p>VDO Resistive Sender: The TP-4 supports the VDO 2, 5 and 10 Bar senders. VDO pressure senders used to measure fuel pressure require the fuel isolation kit available from VDO.</p> <p>Rotax 4-20mA Sender: The TP-4 supports the 4-20mA pressure sender as used in Rotax 912/914 engines.</p> <p>Voltage Output Pressure Senders: e.g. UMA senders that output a voltage signal. A 0.5-4.5V sender selection is also available.</p> <p>UMA N/T 1EU07G(M): 7PSI (0.5Bar) for carbureted engine (Rotax) UMA N/T 1EU35G(M): 35PSI (2.4Bar) for carbureted engine (Lycoming/Continental) UMA N/T 1EU100G(M): 100PSI (6.9Bar) for injected (Lycoming / Continental) (M) is MGL modified senders</p> <p>The TP-4 includes linearisation curves for the UMA N/T 1EU07, N/T 1EU35, N/T 1EU70, N/T 1EU70A, N/T 1EU100 and N/T 1EU150 pressure senders</p> <p>User defined senders: TP-4 has a user sender calibration feature that can be customized for senders not listed above.</p>
Temperature Sensors	<p>VDO Resistive Senders: VDO 120°C and VDO 150°C thermistor senders supported.</p> <p>MGL NTC Resistive Sender: Echlin TS920SA (32040) automotive temperature sender</p> <p>MGL Precision LM335 semiconductor: Based on ON Semiconductors LM335 temperature sensor</p>

	<p>Westach Resistive Senders: Westach 399 thermistor series temperature senders.</p> <p>User defined senders: The TP-4 has a user sender calibration feature that can be customized for senders not listed above</p>
Current Sensors	Closed Loop Current Sensor
Fuel level input	Maximum voltage: 5V, 5mA maximum current
Fuel level senders supported	<p>Any resistive type with common ground and capacitive probes with active voltage outputs up to 5V level (push pull or pull up).</p> <p>The analog channel dip switch should be disabled and an external 1k resistor should be connected between the fuel level input and the +5V sensor power</p>
Generic Sensors	0 to +5V
Voltage measurement range	Up to 32Vdc
Voltage resolution	0.1V

8 Operating the alarms

The alarm output can be used to switch an external alarm indicator. The external alarm switch is an open collector transistor switch to ground with a maximum rating of 0.25A DC. It is possible to wire the alarm contacts of several Stratomaster instruments in parallel should this be desired. To avoid false activation of the alarms, the alarm function is only active 10 seconds after the instrument has powered up.

9 Firmware Upgrading

The TP-4 can be upgraded in the field by connecting the RS232 port to a PC and running the firmware update program. **Note that only the RS232 port can be used to upgrade the firmware.**

Please see the Blaze firmware upgrading document for more information.

10 Installation

10.1 Temperature senders

VDO Resistive senders: The TP-4 supports the VDO 120°C and 150°C thermistor automotive senders. The internal pull up resistor dip switch for the resistive temperature sender input must be in the “ON” position.

MGL NTC resistive senders: A suitable sender with the same thread used by Rotax can be obtained from MGL Avionics (manufacturer Echlin). The internal pull up resistor dip switch for the resistive temperature sender input must be in the “ON” position.

Most NTC senders require a single wire connected as shown in the installation diagram. The sender is grounded via the engine block. The ground terminal of the gauge input should be connected to the engine block. Some NTC senders have two wires. In this case it is not required that the sender housing itself is connected to the engine block. Wire the second wire to the reference ground terminal.

MGL Precision senders (On Semiconductors LM335): These are senders containing a semiconductor temperature measurement device. They can be used for water or oil temperature. These senders are available in two types: an encapsulated version with a brass housing suitable for Rotax thread; a second uncommitted version contains only the sensor itself. This can be conveniently mounted inside an existing sender housing after you remove the original insides of the sender. This is intended to give you a solution for unusual or difficult to obtain senders. The internal pull up resistor dip switch for the resistive temperature sender input must be in the “ON” position.

Connect the green wire to ground and the red wire to the analog input channel.

Westach Resistive senders: The TP-4 supports the Westach 399 series senders. The internal pull up resistor dip switch for the resistive temperature sender input must be in the “ON” position.

User defined senders: The TP-4 has a user sender calibration feature that can be customized for senders not listed above.

10.2 Pressure senders

VDO Resistive senders: The TP-4 includes linearisation curves for the VDO 2, 5 and 10 Bar pressure senders. The internal pull up resistor dip switch for the resistive pressure sender input must be in the “ON” position.

4-20mA Pressure Senders: The TP-4 supports the 4-20mA pressure sender as used in Rotax 912/914 engines. The supplied 100Ohm 1/4W resistor must be connected across the analog input channel to ground. The internal pull up resistor dip switch for the 4-20mA current sender input must be in the “OFF” position. Only channel 1 to 3 can be used for the 4-20mA pressure sender if using the internal measurement circuit and only the OILP, AUX 1 and AUX 2 can be used if using the external RDAC.

Voltage output pressure senders: The TP-4 includes linearisation curves for the UMA N/T 1EU07, N/T 1EU35, N/T 1EU70, N/T 1EU70A, N/T 1EU100 and N/T 1EU150 pressure senders. The TP-4 also has a 0.5-4.5V sender selection. The internal pull up resistor dip switch for the 0.5-4.5V sender input must be in the “OFF” position.

User defined senders: The TP-4 has a user sender calibration feature that can be customized for Resistive, 4-20mA as well as Voltage output senders.

10.3 Senders that are grounded in the engine block

Single wire senders require that their mounting arrangement (thread) has a very good electrical contact with the engine block. Avoid the use of any sealant or tapes as these may cause a bad electrical connection. Further to this it is very important that the engine block has a good electrical connection to the negative supply terminal of the TP-4. Any voltage drop caused by other equipment on the ground wire will cause incorrect readings. The best way to ensure a good connection is to wire a single connection between the TP-4 ground terminal (any of these terminals) and the engine block. Do not wire this anywhere else and do not allow any other equipment to use this wire as a current return path.

10.4 UMA Voltage output pressure sender



Pinout:

White/Orange: +12Vdc
 White: Signal
 White/Blue: Ground
 Shield: Ground

10.5 ROTAX 912/914 4-20mA Pressure sender

DIMENSIONS for reference only mm (in)

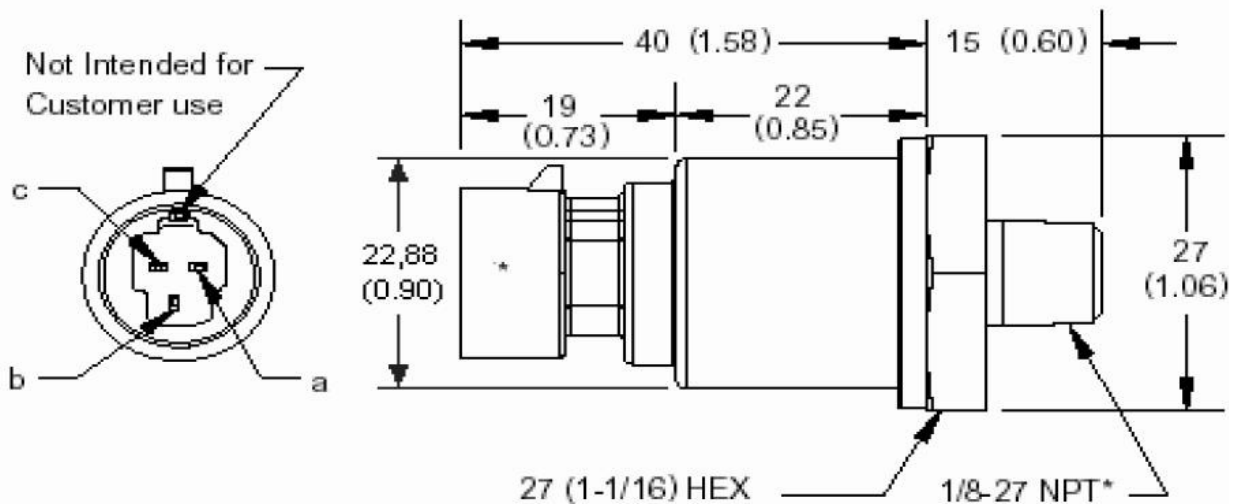

The sensor cable is approximately 3m long and has 3 leads. The black lead is not to be connected and has no function. The Red lead from the sensor has to be connected to the positive bus via a fuse or circuit breaker. The white lead (Output signal) has to be connected directly to the TP-4 analog input channel. The supplied 100Ohm 1/4W resistor must be connected across the analog input channel to ground. The internal pull up resistor dip switch for the 4-20mA current sender input must be in the "OFF" position.

10.6 Closed Loop Current Sensor



The MGL Avionics magnetic closed loop current sensor provides a 0.5V to 4.5Vdc output voltage which is proportional to a 50A bi-directional input current.

Advantages of closed loop current sensors over conventional current measurements techniques is that they provide the highest accuracy, are ideal for noisy electrical environments and they provide complete electrical isolation from the current carrying conductor.

Please see the Closed Loop Current Sensor manual for connection information

10.7 External RDAC (Remote Data Acquisition) Connection (Optional)

The TP-4 can use an external RDAC unit as the source for the analog signals. Using an external RDAC may be beneficial as it will reduce the wiring from the engine compartment to the cockpit. Only the CAN High and CAN Low connections need to be made between the RDAC unit and the TP-4 in order for this to work. Select “RDAC” for the data source in the various analog channel setup menus if using the external RDAC option. The RDAC unit is optional and is purchased separately.

TP-4 Channel 1 = RDAC OILT

TP-4 Channel 2 = RDAC OILP

TP-4 Channel 3 = RDAC AUX1

TP-4 Channel 4 = RDAC AUX2

10.8 Cable connections

Main connector (D15HD connector: Unit Female, Cable Male)

D15HD Pin	Wire Color	Function
1	Red	8-30Vdc power via power switch / circuit breaker and fuse.
2	Black	Ground. Connect the ground to the engine block, and the engine block to the battery negative. Do not connect the TP-4 ground directly to the battery negative. This must be routed via the engine block.
3	-	RS232 Transmit data (Firmware upgrading)
4	-	RS232 Receive data (Firmware upgrading)
5	Green	Analog Input 2
7	Orange	Analog Input 1
9	Red/Yellow Stripe	Analog Input 4
10	Grey	Analog Input 3
12	Purple	CAN Low (Used for optional external RDAC)
13	Pink	CAN High (Used for optional external RDAC)
15	White	Alarm Output (Open collector)

10.9 Dipswitch settings

Use a small screwdriver to change the switch direction.

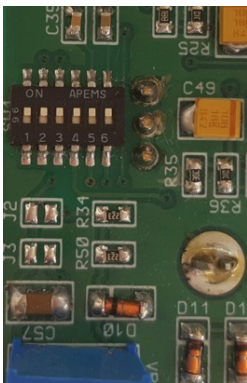

Dipswitch	Function
1	Analog Input Channel 1 Pull up resistor (On=Enable, OFF=Disable)
2	Analog Input Channel 2 Pull up resistor (On=Enable, OFF=Disable)
3	Analog Input Channel 3 Pull up resistor (On=Enable, OFF=Disable)
4	Analog Input Channel 4 Pull up resistor (On=Enable, OFF=Disable)

10.10 Connection Diagram

The use of an external 1A fuse is recommended. Connect the supply terminals to your aircrafts power supply. The TP-4 can be used on both 12V and 24V without the use of any pre-regulators. Ensure that the supply voltage will not drop below 8V during operation as this may result in incorrect readings.

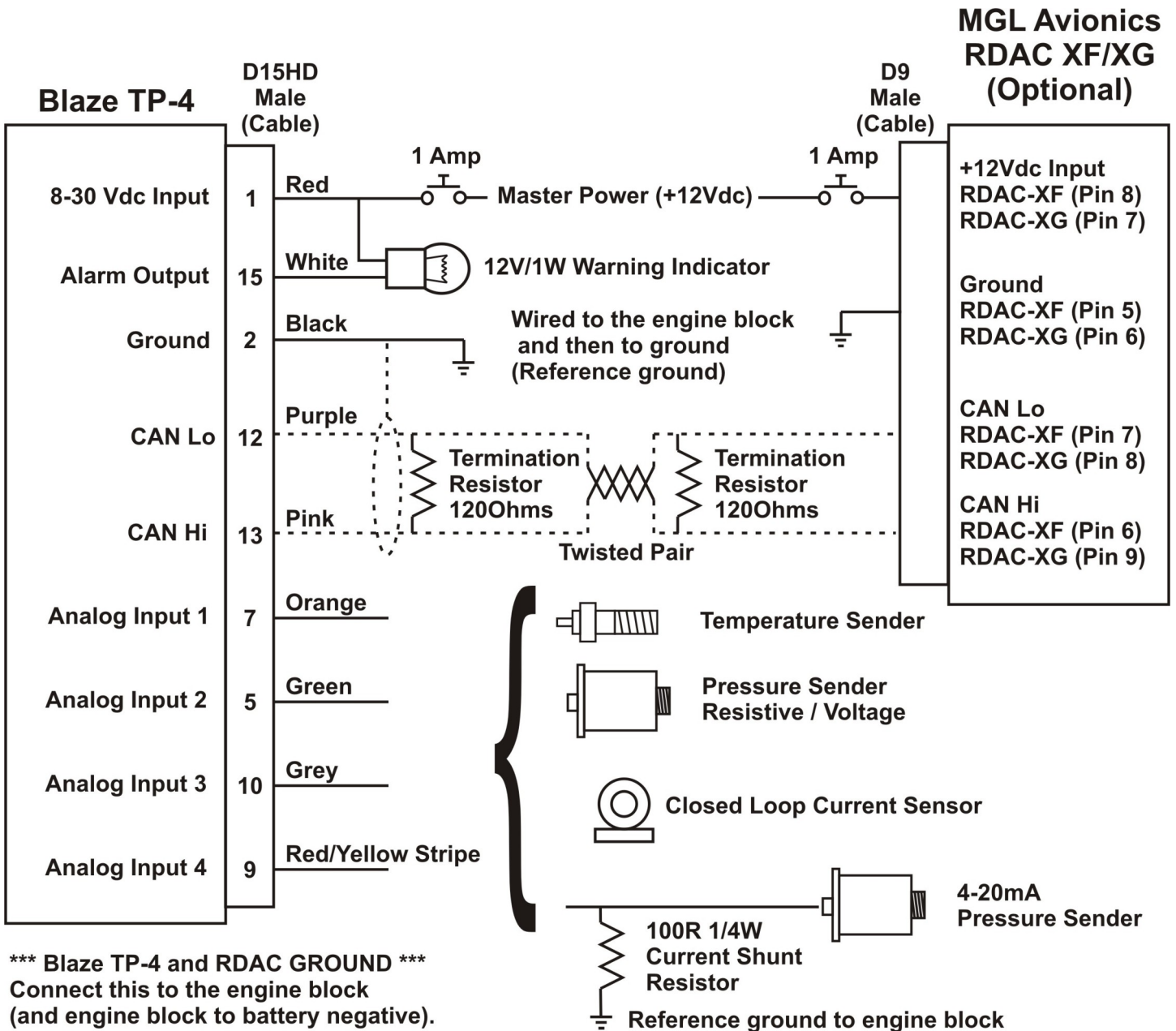

*** Blaze TP-4 and RDAC GROUND ***
 Connect this to the engine block (and engine block to battery negative). Do not connect directly to the battery negative. This must be routed via the engine block.

Bodies of temperature and pressure senders must have electrical connection to engine block. Engine block must have electrical connection to instrument ground.

11 Dimensions

Stratomaster Blaze 3.125" (80mm) Dimensions

FRONT VIEW

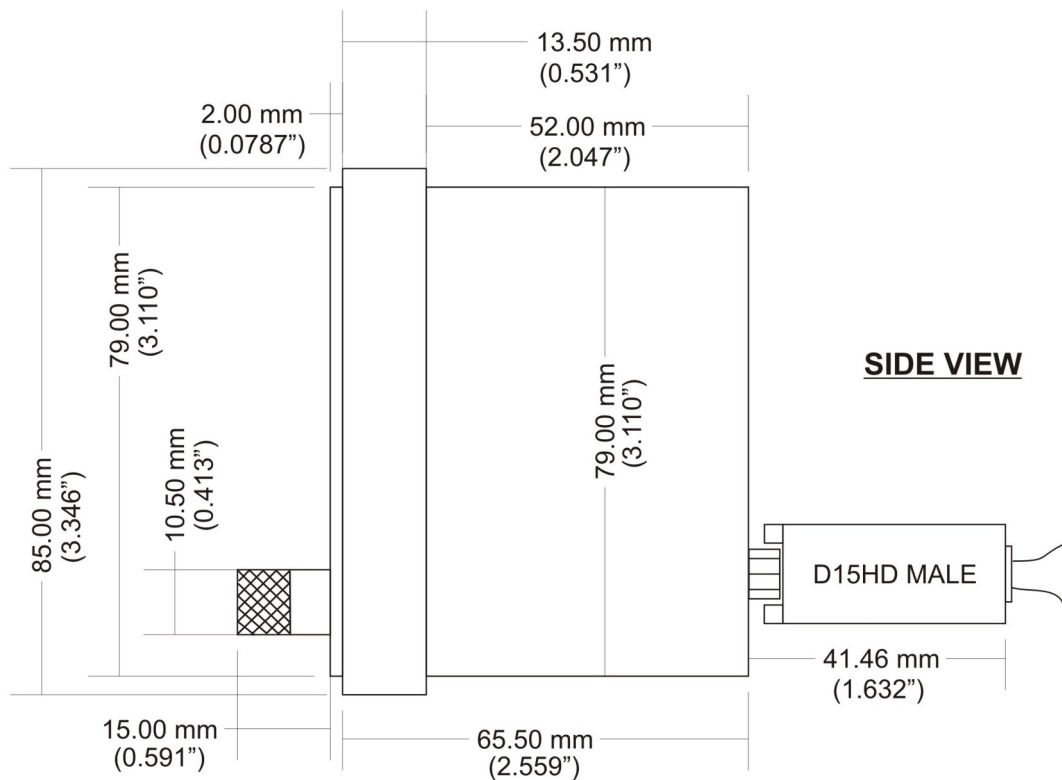
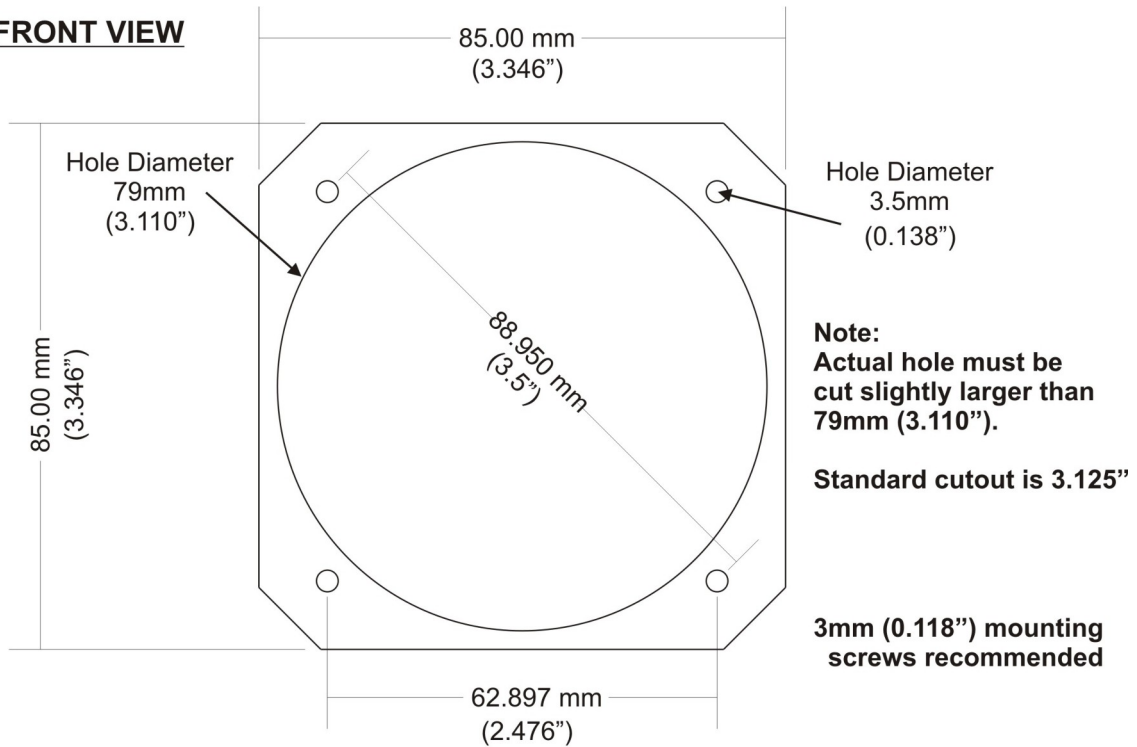

12 Cleaning

The unit should not be cleaned with any abrasive substances. The screen is very sensitive to certain cleaning materials and should only be cleaned using a clean, damp cloth.

Warning: The TP-4 is not waterproof, serious damage could occur if the unit is exposed to water and/or spray jets.

13 Warranty

This product carries a warranty for a period of one year from date of purchase against faulty workmanship or defective materials, provided there is no evidence that the unit has been mishandled or misused. Warranty is limited to the replacement of faulty components and includes the cost of labor. Shipping costs are for the account of the purchaser.

Note: Product warranty excludes damages caused by unprotected, unsuitable or incorrectly wired electrical supplies and or sensors, and damage caused by inductive loads.

14 Disclaimer

Operation of this instrument is the sole responsibility of the purchaser of the unit. The user must make themselves familiar with the operation of this instrument and the effect of any possible failure or malfunction.

This instrument is not certified by the FAA. Fitting of this instrument to certified aircraft is subject to the rules and conditions pertaining to such in your country. Please check with your local aviation authorities if in doubt. This instrument is intended for ultralight, microlight, home built and experimental aircraft. Operation of this instrument is the sole responsibility of the pilot in command (PIC) of the aircraft. This person must be proficient and carry a valid and relevant pilot's license. This person has to make themselves familiar with the operation of this instrument and the effect of any possible failure or malfunction. Under no circumstances does the manufacturer condone usage of this instrument for IFR flights.

IMPORTANT NOTICE:

You must make your own determination if the products sold by MGL Avionics are safe and effective for your intended applications. MGL Avionics makes no representations or warranties as to either the suitability of any of the products we sell as to your particular application or the compatibility of any of the products we sell with other products you may buy from us or anywhere else, and we disclaim any warranties or representations that may otherwise arise by law. Also, we offer no specific advice on how to install any of the products we sell other than passing along anything that may have been provided to us by the manufacturer or other issues. If you are in need of further information or guidance, please turn to the manufacturer, FAA Advisory Circulars and guidance materials, the Experimental Aircraft Association, or other reputable sources.

Continuing development sometimes necessitates specification changes without notice.

Other instruments in the *Stratmaster Blaze* series

AHRS-2	Artificial Horizon and Magnetic Compass Indicator
AHRS-4	Self contained Artificial Horizon and Magnetic Compass Indicator
ALT-6	Altimeter and Vertical Speed Indicator (VSI)
ALT-7	Altimeter and Vertical Speed Indicator (VSI) with a transponder compatible RS232 & parallel Gillham code output
ASI-5	Airspeed Indicator (ASI)
ASV-2	Altimeter, Airspeed (ASI) and Vertical Speed Indicator (VSI)
EMS-2	Engine Monitoring System
FF-5	Fuel Computer
FLIGHT-3	Primary Flight Instrument
INFO-2	Information Display (G-Force meter, UTC and Local Time, Slip Indicator, Outside Air Temperature (OAT), Battery Voltage, Current and charge display, Flight Timer & Flight Log, Stopwatch, Countdown Timer and Alarm)
MAG-2	Magnetic Compass Indicator
MAP-4	Manifold Pressure and RPM Indicator
RPM-2	Universal Engine / Rotor RPM Indicator
TC-5	4 Channel Thermocouple (EGT/CHT) Indicator
TC-6	12 Channel Thermocouple (EGT/CHT) Indicator
TP-4	4 Channel Universal Analog Input (Pressure/Temperature/Current/Volts) Indicator